



EzMate™ 401 / 601

Automated Pipetting System

Operation Manual

Ver. 2.2



Trademarks:

Beckman[®], Biomek[®] 3000 (Beckman Coulter Inc.); Roche[®], LightCycler[®] 480 (Roche Group); DyNAmo™ (Finnzyme Oy); SYBR[®] (Molecular Probes Inc.); Invitrogen™, Platinum[®] (Invitrogen Corp.), MicroAmp[®] (Applied Biosystems); Microsoft[®] , Windows[®] 7 (Microsoft Corp.). All other trademarks are the sole property of their respective owners.

Copyright Notice:

No part of this manual may be reproduced or transmitted in any form or by any means, electronic or mechanical, for any purpose, without prior written permission of Arise Biotech Corp.

Notice:

This product only provides pipetting functionality. Arise Biotech Corp. does not guarantee the performance and results of the assay and reagent.

Table of Contents

1.	Safety Precautions	1
2.	Product Introduction	3
2.1	Features	3
2.2	Hardware Overview	4
2.2.1	Outlook	4
2.2.2	Control Notebook Computer.....	6
2.2.3	Automated Pipetting Module (APM).....	7
2.2.4	Labware Adapters	8
2.2.5	CoolBlock™ Operation and Performance	11
2.2.6	Disposable Used Tip Tray	12
2.3	Software Overview	12
3.	Getting Started	13
3.1	Unpacking	13
3.2	Content List.....	15
3.3	Instrument Installation	16
3.3.1	APM Installation and Removal.....	16
3.3.2	Adapters Installation	17
3.3.3	Disposable Used Tip Tray Installation.....	17
3.3.4	Computer Connection	18
3.4	Power On the Instrument	19
3.5	Starting EzStarter	20
3.6	Exiting and Shutting down.....	20
4.	Software	21
4.1	Menu Map of EzStarter.....	21
4.2	File	22
4.3	Edit.....	23
4.4	Protocol.....	24
4.5	Labware.....	25
4.5.1	Enable the Tubes in worktable.....	25
4.5.2	Enable the Plates in worktable.....	25
4.5.3	Enable the Tips in worktable.....	26
4.6	Report.....	26
4.6.1	Protocol Report	26

4.6.2	Log Report	27
4.7	System.....	29
4.7.1	Buzzer	29
4.7.2	COM	29
4.7.3	APS Connection.....	30
4.7.4	Robot Test	30
4.7.5	Account	33
4.7.6	Software	33
4.7.7	Maintenance Aphorism	36
4.8	Help.....	36
4.8.1	How Do I.....	36
4.8.2	About.....	36
5.	Work Tab Overview	37
5.1	Icons in the Work Tab for EzMate 401/601	37
5.2	Worktable	38
5.3	Protocol List.....	39
5.4	Pre-Run and Run.....	39
5.5	Properties	39
6.	Operation.....	41
6.1	Create A New Protocol.....	41
6.2	Selecting the Labwares	42
6.2.1	Reagent Area (R1 and R2)	42
6.2.2	Worktable Area (A/B/C for EzMate 401, A/B/C/D/E for EzMate 601)	43
6.2.3	Worktable Area (D for EzMate 401, F for EzMate 601)	45
6.2.4	Removing labwares from Area	46
6.3	Editing the Protocol	46
6.3.1	Adding a command	46
6.3.2	Removing commands from the procedure	47
6.3.3	Duplicating a command	48
6.3.4	Inserting a command.....	49
6.3.5	Exchanging a command	50
6.3.6	Resetting source and destination of a command.....	51
6.4	Command Overview	53
6.4.1	Liquid Transfer (LT)	53
6.4.2	Multi-Dispense (MD).....	55
6.4.3	Serial Dilution (SD)	59
6.4.4	Mix.....	63

6.4.5	Hold.....	64
6.4.6	Loop	65
6.5	Commands' Advanced Settings	68
6.5.1	Liquid Transfer's (LT) Advanced Setting	68
6.5.2	Multi-Dispense's (MD) Advanced Setting.....	72
6.5.3	Serial Dilution's (SD) Advanced Setting	72
6.5.4	Mix's Advanced Setting.....	75
6.6	Run and Pre-run	75
6.6.1	Pre-run a protocol.	76
6.6.2	Run a protocol.....	76
7.	Maintenance	79
7.1	Cleaning the Worktable.....	79
7.2	Cleaning the Automated Pipetting Module (APM)	79
7.3	Servicing the Automated Pipetting Module (APM).....	79
7.4	Cleaning the Adapters	80
7.5	Replacing a Fuse	80
8.	Troubleshooting	81
8.1	Error Messages.....	81
	Appendix A : Recommended Consumables.....	82
	Appendix B : Technical specifications.....	85
	Appendix C : EzMate 401/601 Sample Protocols	87
	Appendix D : CE Declaration	88
	Appendix E : EzStarter Installation and Uninstallation	89
	Appendix F : Ordering Information	93

1. Safety Precautions

1. It is recommended to carefully read this operating manual prior to operating the EzMate 401/601 Automated Pipetting System. To ensure safe operation and avoid problems that might arise while using the EzMate 401/601 Automated Pipetting System, it is essential to observe the following points. Do not use the machine in a potentially explosive environment or with potentially explosive chemicals.
2. Install the machine in location free of excessive dust.
3. Avoid placing the machine in direct sunlight.
4. Place the machine on a flat and sturdy surface, capable of withstanding the weight.
5. The machine should be in an indoor temperature of 15 ~ 30°C, relative humidity 40 ~85%.
6. Keep the side and rear of the machine at least 10cm from the wall or other machine.
7. Make sure the power source conforms to the required power supply specifications.
8. To avoid electric shock, make sure the machine is plugged into a grounded electrical outlet.
9. Do not allow water or any foreign objects in the various openings of the machine.
10. Switch off the machine prior to cleaning or performing service on the machine, such as replacing the fuses.
11. Repairs should be carried out by authorized service personnel only.
12. Open the lid only when the XYZ axes is not moving.
13. Read and understand the Material Safety Data Sheets (MSDSs) provided by the manufacturers of the biological and chemical substances before you use and dispose.
14. For research use only. When using the machine in diagnostic procedures with an in vitro diagnostic medical device, the IVD Directive should be applied separately.
15. Users should be informed on the correct usage and user protection measures when handling hazardous substances. Use protective gloves when handling infectious substances (such as human samples or reagents)..
16. It is recommended to wear a mask and goggle to prevent users from inhaling hazardous vapors from the machine.
17. Follow the manufacturer's safety instructions when operating the machine.

EzMate™ 401/601 Automated Pipetting System



Pinching Hand Warning Label: Please be aware of pinching hands.



Electric Shock Warning: Please be aware of electric shock.



Warning: Please be aware of the dangers.

2. Product Introduction

EzMate™ 401/601 is an automatic, high-precision pipetting system specially designed for low-volume PCR/qPCR sample preparation. Its design concept is to replace tedious and repetitive pipetting of PCR/qPCR sample preparation traditionally performed by hand-held manual pipettor, and at the same time keep the operation of a manual pipettor. EzMate™ 401/601 will save your time and money through reliable results. You will be assured to “Work Smart” with the EzMate™ 401/601.

2.1 Features

Easy to Use

- Interchangeable 4-position (EzMate 401) or 6-position (EzMate 601) 96/384-well plate(SBS)/tip rack worktable and 2 reagent areas.
- Software: EzStarter™ can be mastered in one hour. No technician required.
- Built-in PCR/qPCR setup protocols can be easily modified and transferred via USB memory stick.
- 1/8-channel, 50µl or 200µl, Automated Pipetting Module (APM) can be exchanged without tools.

Easy to Afford

- The most affordable Automated Pipetting System available in the market.
- EzTip™ robotic tips compatible with Beckman® Biomek® 3000 model.
- CoolBlock™ keeps sensitive reagents/samples for more than 60 minutes at 7 °C.
- Saving reagent costs by reducing human errors and using more dense plates.

Easy to Service

- Mail-in calibration and service of Automated Pipetting Module (APM).
- Online PC software update.
- Compact and light-weight.

Accurate and Precise

- Automated Pipetting Module (APM) is calibrated by ISO-8655 standards.
- Excellent results for qPCR standard curve and replicates.
- Better Precision than manual pipetting.

2.2 Hardware Overview

The EzMate 401/601 Automated Pipetting System includes a base platform (“APS”), an Automated Pipetting Module (APM), a control Notebook computer and other adapters for labwares. The base platform (APS) is composed of the X/Y/Z axes motion mechanism, a power supply and some control circuit boards (PCBs) which are in charge of motion control, communication and APM control. More information is described below.

2.2.1 Outlook

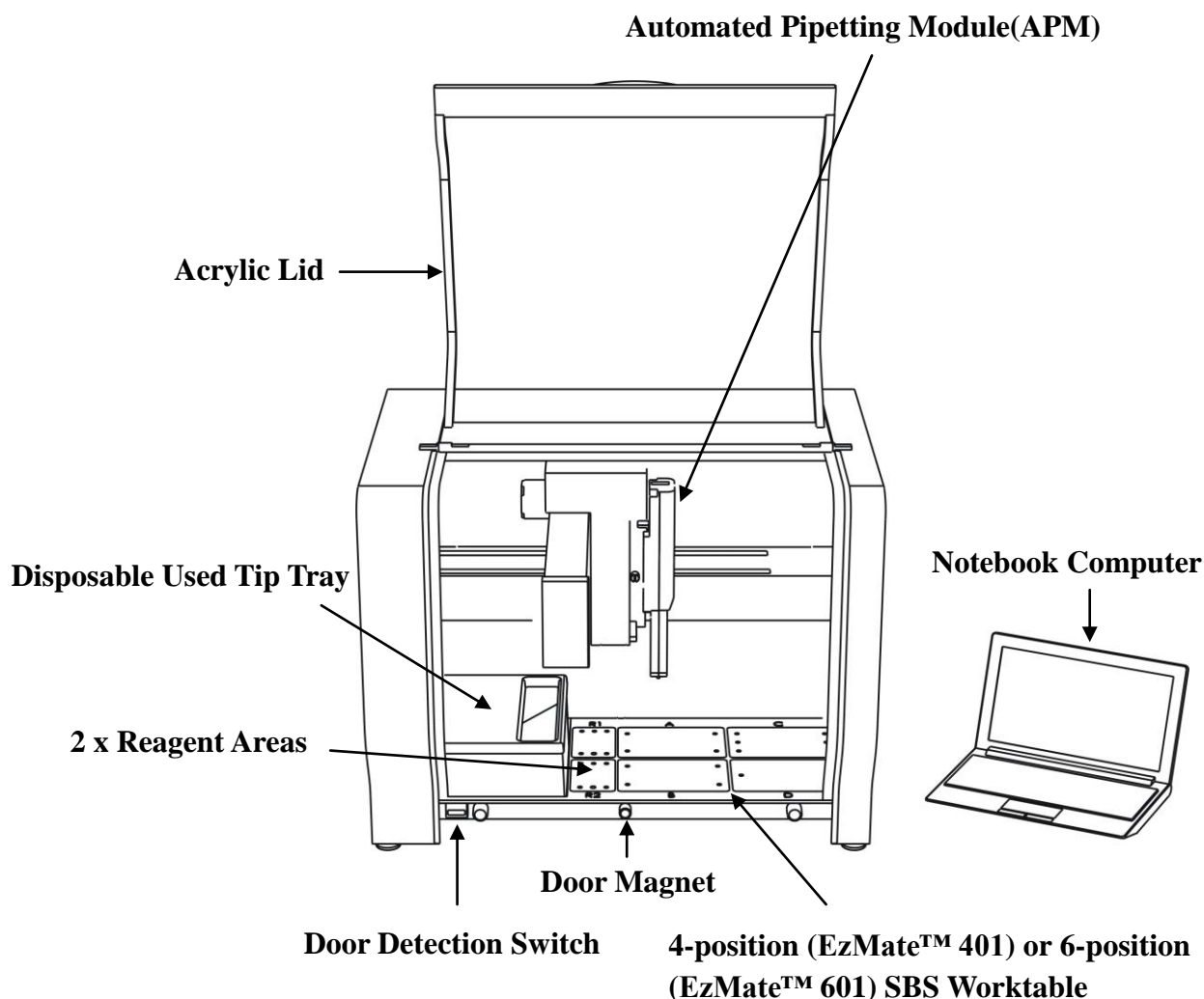

Figure 1. Front View

2 Product Introduction

Name	Function
Automated Pipetting Module (APM)	APM is the core engine for accurate and precise pipetting. APM can be exchanged without tools. All APMs are calibrated using ISO-8655 standards. The specifications of APM are shown in section 2.2.3.
Acrylic Lid	Used for the protection of dust and emergency stop. The movement of XYZ axis will stop, once the Acrylic Lid is open. To ensure the Door Detection Switch is activated, close the front acrylic door to the door magnet and shut it tightly.
2 x Reagent Areas	R1/R2 Area: accommodates the R1 adapter for 2 x 4 1.5ml/2ml micro tubes, and the R2 adapter for 6 x 2ml free standing tubes and 1 x 5ml bottle, and reservoir adapter for 80ml reservoir. CoolBlock™ adapters are available for Reagent Areas.
EzMate 401: 4-position SBS Worktable	A/B/C Area: accommodates the elevated and CoolBlock™ adapters for PCR plates/strips/1.5ml tube, and deep well adapter for deep well plate. C/D Area: accommodates the tip racks.
EzMate 601: 6-position SBS Worktable	A/B/C/D/E Area: accommodates the elevated and CoolBlock™ adapters for PCR plates/strips/1.5ml tube, and deep well adapter for deep well plate. C/D/E/F Area: accommodates the tip racks.
Disposable Used Tip Tray	Capacity > 400 tips
Door Magnet	Lock the acrylic Lid into its place.
Door Detection Switch	The operation of XYZ axis will stop, once the door opening is detected.
Notebook Computer	Used in running the control software: EzStarter. Microsoft® Windows® 7 operating system or higher version is included.

Note:

SBS represents the Society for Biomolecular Screening (SBS). The SBS worktable and its adapters accommodate the SBS recommended labwares.

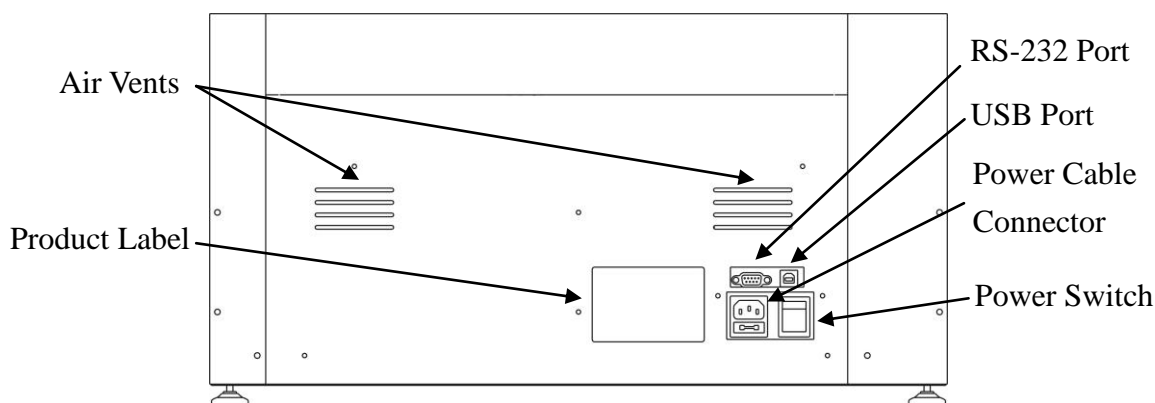

Figure 2. Rear View

Name	Function
Power Cable Connector	Power cable socket and fuse drawer.
Power Switch	Power On/Off switch. I: ON, O: Off.
USB Port	For connection with Notebook Computer.
RS-232 Port	For connection with computers that do not have USB ports.
Air Vents	For air ventilation.
Product Label	Indicates the model name, serial number, power specification, and other important information

2.2.2 Control Notebook Computer

EzMate 401/601 is controlled by a Notebook Computer. The specifications of the Notebook Computer can be upgraded to a higher performance model in the future. For detailed specifications and operation of the Notebook Computer, please read its User Guide, Quick Guide and product label carefully. The Microsoft® operation software English Windows® 7 (or other higher version) and EzMate 401/601 control software: EzStarter is pre-installed in the Notebook Computer.

Note:

To avoid any computer virus or software conflict, it is highly recommended not to connect the Notebook Computer with Internet and not to install any application software in this Notebook Computer.

The calibration information of XYZ axes and labware adapters is stored in the EzStarter control software. To switch the Notebook Computer between different EzMate 401/601 units will lose the original calibration information and affect the positioning of adapters.

The methods and log files of EzStarter can be transferred easily by an USB storage device, such as a memory stick and hard drive, or multi-card reader that accepts Secure Digital (SD), MultiMediaCard (MMC), and Memory Stick (MS).

Minimal PC specifications required to run EzStarter are as followed:

- 1 gigahertz (GHz) or faster 32/64-bit (x86) processor
- 1 gigabyte (GB) RAM (32/64-bit)
- 16 GB available hard disk space (32/64-bit)
- DirectX 9 graphics device with WDDM 1.0 or higher driver

2.2.3 Automated Pipetting Module (APM)

Four different interchangeable APM models, including single and 8-channel for two volume ranges: 50µl and 200µl. Their product specifications are shown below.

The function of APM can be seen in Figure 3. 1- and 8-channel APM.

Catalog No.	Channels	Volume Range (µl)	Increment (µl)	Accuracy (Rel.±)	Precision (Rel. CV≤)
275-ezar01-00	1	1 ~ 50	0.5	7.0-1.0%	7.5-0.4%
275-ezar02-00	1	10 ~ 200	1	3- 0.8%	1-0.15%
275-ezar03-00	8	1~ 50	0.5	7.0-1.0%	7.5-0.4%
275-ezar04-00	8	10 ~ 200	1	3- 0.8%	1-0.15%

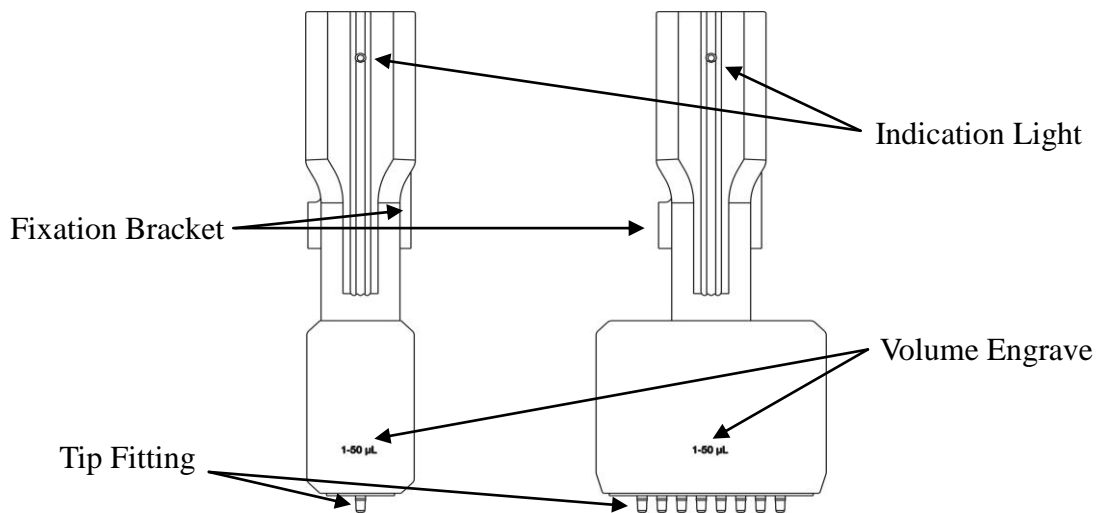

Figure 3. 1- and 8-channel APM

2.2.4 Labware Adapters

EzMate 401/601 supplies various adapters to accommodate different labwares. The list below shows the available adapters and labwares. To expand EzMate 401/601's flexibility, more new adapters will be designed in the future. Please take some time to visit our web site at www.arisebio.com.tw for the latest adapters.

The worktable has indented lines and symbols to display the 4-position (EzMate 401, Area A/B/C/D) or 6-position (EzMate 601, Area A/B/C/D/E/F) and Reagent Area R1/R2. Inside the Areas, there are fixation holes for the positioning of adapters. Insert the pins of the adapters to these fixation holes to accurately position the adapters.

CoolBlock™ can maintain the sensitive samples/reagents at 7°C for more than 60 minutes. The typical CoolBlock™ (refer Figure 4.) includes 2 parts: the Core and the Insulation Housing. To use CoolBlock™, store it in -20°C freezer for more than 3 hours before use. The Insulation Housing will maintain the low temperature of Core and position itself in the worktable.

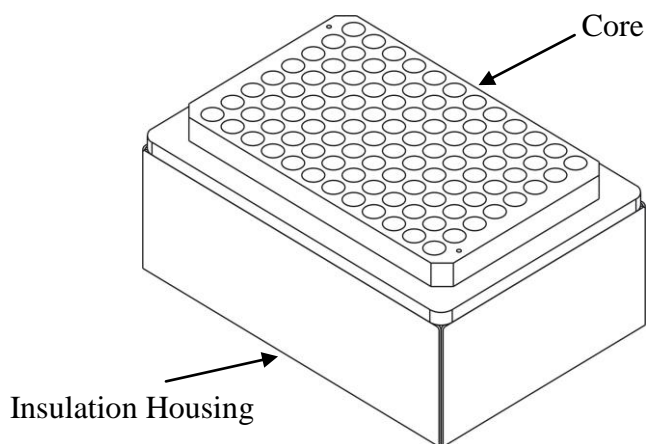





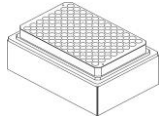
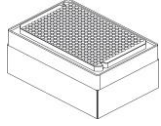

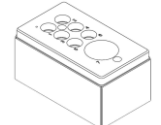
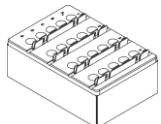



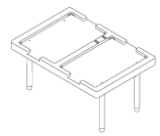
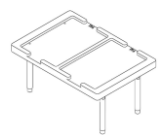









Figure 4. CoolBlock™ 96 Adapter

2 Product Introduction

Catalog no.	Description	Applied Labware	Worktable Area	Adapter
275-ezar21-00	96 tips rack adapter	<ul style="list-style-type: none"> ● 96x50µl tips rack ● 96x200µl tips rack 	C,D(401); C,D,E,F(601)	
275-ezar22-00	Elevated 96-well PCR plate adapter	<ul style="list-style-type: none"> ● 96-well PCR plates ● Single 0.2ml PCR tube ● 0.2ml PCR strips 	A,B,C(401); A,B,C,D,E(601)	
275-ezar23-00	Elevated 384-well PCR plate adapter	<ul style="list-style-type: none"> ● 384-well PCR plates 	A,B,C(401); A,B,C,D,E(601)	
275-ezar24-00	Deep well plate adapter	<ul style="list-style-type: none"> ● 96-well deep-well plates 	A,B,C(401); A,B,C,D,E(601)	
275-ezar26-00	4 x 2 1.5ml tubes adapter	<ul style="list-style-type: none"> ● 1.5ml micro tubes 	R1,R2	
275-ezar27-00	3 x 2 2 ml storage tubes and 1 x 5ml bottle adapter	<ul style="list-style-type: none"> ● 2ml storage tubes ● 5ml storage tubes 	R1,R2	
275-ezar30-00	CoolBlock™ 96 adapter for 96-well PCR plates	<ul style="list-style-type: none"> ● 96-well PCR plates ● Single 0.2ml PCR tube ● 0.2ml PCR strips 	A,B,C(401); A,B,C,D,E(601)	
275-ezar31-00	CoolBlock™ 384 adapter for 384-well PCR plates	<ul style="list-style-type: none"> ● 384-well PCR plates 	A,B,C(401); A,B,C,D,E(601)	
275-ezar34-00	CoolBlock™ R10 adapter for 4 x 2 1.5ml tubes	<ul style="list-style-type: none"> ● 1.5ml micro tubes 	R1,R2	
275-ezar35-00	CoolBlock™ R20 adapter for 3 x 2 2 ml storage tubes and 1 x 5ml bottle	<ul style="list-style-type: none"> ● 2ml storage tubes ● 5ml storage tubes 	R1,R2	
275-ezar37-00	CoolBlock™ 20 adapter for 20-well 1.5ml tubes	<ul style="list-style-type: none"> ● 1.5ml micro tubes ● 2ml storage tubes 	A,B,C(401); A,B,C,D,E(601)	

EzMate™ 401/601 Automated Pipetting System

Catalog no.	Description	Applied Labware	Worktable Area	Adapter
275-ezar40-00	20-well 1.5ml adapter	<ul style="list-style-type: none"> ● 1.5ml micro tubes ● 2ml storage tubes 	A,B,C(401); A,B,C,D,E(601)	
275-ezar47-00	Reservoir adapter with 1 x 80ml reservoir	<ul style="list-style-type: none"> ● 80ml reservoir 	R1,R2	
275-ezar49-00	20 x 80ml reservoir	<ul style="list-style-type: none"> ● 80ml reservoir 	R1,R2	
275-ezar66-00	HLA typing adapter for 60/72 well	<ul style="list-style-type: none"> ● 60/72 well Terasaki Tray 	A,B,C(401); A,B,C,D,E(601)	
275-ezar67-00	HLA typing adapter for 96 well	<ul style="list-style-type: none"> ● 96 well Terasaki Tray 	A,B,C(401); A,B,C,D,E(601)	
275-ezar68-00	0.5ml tube adapter for 20 well adapter	<ul style="list-style-type: none"> ● 0.5ml micro tubes 	A,B,C(401); A,B,C,D,E(601)	
275-ezar72-00	3 x 15ml reservoirs adapter	<ul style="list-style-type: none"> ● 15ml reservoir 	R1,R2	
275-ezar73-00	Disposable 15ml reservoir x 9 pcs	<ul style="list-style-type: none"> ● 15ml reservoir 	R1,R2	
275-ezar74-00	3 x 8-strip tubes adapter	<ul style="list-style-type: none"> ● 0.2ml PCR 8- strip tubes 	R1,R2	
275-ezar75-00	96-well conical bottom adapter	<ul style="list-style-type: none"> ● 96-well PCR plates ● Single 0.2ml PCR tube ● 0.2ml PCR strips 	A,B,C(401); A,B,C,D,E(601)	

Catalog no.	Description	Applied Labware	Worktable Area	Adapter
275-ezar76-00	Elevated ELISA / cell culture adapter	● 6~96-well ELISA/Cell culture plates	A,B,C(401); A,B,C,D,E(601)	
275-ezar78-00	Illumina 48-well plate adapter	● Illumina 48-well plate	A,B,C(401); A,B,C,D,E(601)	

2.2.5 CoolBlock™ Operation and Performance

● Operation

Prior to usage, store the CoolBlock™ adapters in the freezer at -20°C for at least 3 hours. After removing the CoolBlock™ adapter from the freezer to a normal room temperature environment, it will be required to stay on the bench for 5 minutes. Users can then put the labwares into the CoolBlock™ adapter, and maintain the samples/reagents inside the labwares under 7°C over 1 hour.

Caution!

Once the CoolBlock™ adapter is removed from the freezer, do not immediately put the tubes into it. Otherwise, the samples in the tubes will freeze.



Warning! Do not autoclave the CoolBlock™.



Warning! Do not store the CoolBlock™ under -20°C.

● Performance

All CoolBlock™ adapters can maintain its temperature under 7°C over 1 hour after being removed from -20°C freezer. The temperature profile of CoolBlock™ 96 and CoolBlock™ R1 can be seen in the figure 5 and figure 6.

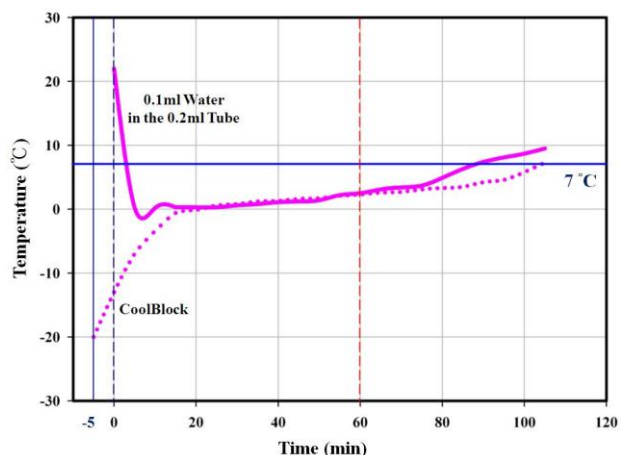

Figure 5. The performance of CoolBlock™ 96

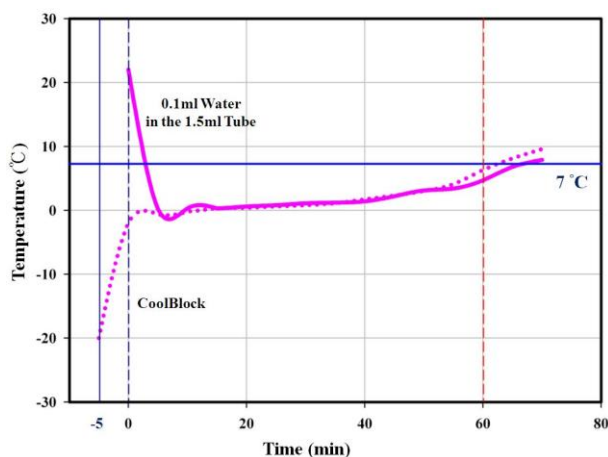

Figure 6. The performance of CoolBlock™ R1

2.2.6 Disposable Used Tip Tray

The standard Disposable Used Tip Tray contains more than 400 x 200µl tips. The Disposable Used Tip Tray can be easily removed for used tips dumping and disinfection. To prevent contamination to samples or reagents, a disposable Tray Cover can be placed on top of the Disposable Used Tip Tray.

2.3 Software Overview

EzStarter is a powerful, graphic control software specially designed for the application of PCR/qPCR setup. For the ease of operation, all the procedures and labwares required for PCR/qPCR setup are considered during the product design phase. Notebook Computer and Microsoft® Windows® 7 operating system are required for the operation of EzStarter.

3. Getting Started

3.1 Unpacking

EzMate 401/601 packaging is custom-made to protect the machine during transportation and unpacking. These materials are recyclable and environment-friendly. Please follow the procedures below and refer Figure 7 to unpack the instrument.

1. Cut off the PET strapping bands of carton.
2. Remove the Top Cover.
3. Remove the Outer and Inner Side Walls by pulling it upward.
4. Remove the Accessory Box Partition, Accessory Box.
5. Remove the Top PE foam.
6. Remove the EzMate 401/601 from the Bottom PE foam and place it on a flat surface.
7. Open the lid and remove the Fixation Bracket (**Red**, Figure 8), used in positioning the Y and Z axes during transportation, by unscrewing 7 screws. Screw the 7 screws back to the original holes.

Note:

1. **Important!** Please remove the Fixation Bracket before operating EzMate 401/601. Failing to remove the Fixation Bracket before operation might damage the Y and Z axes.
2. It is recommended to save the packing materials for future usage.

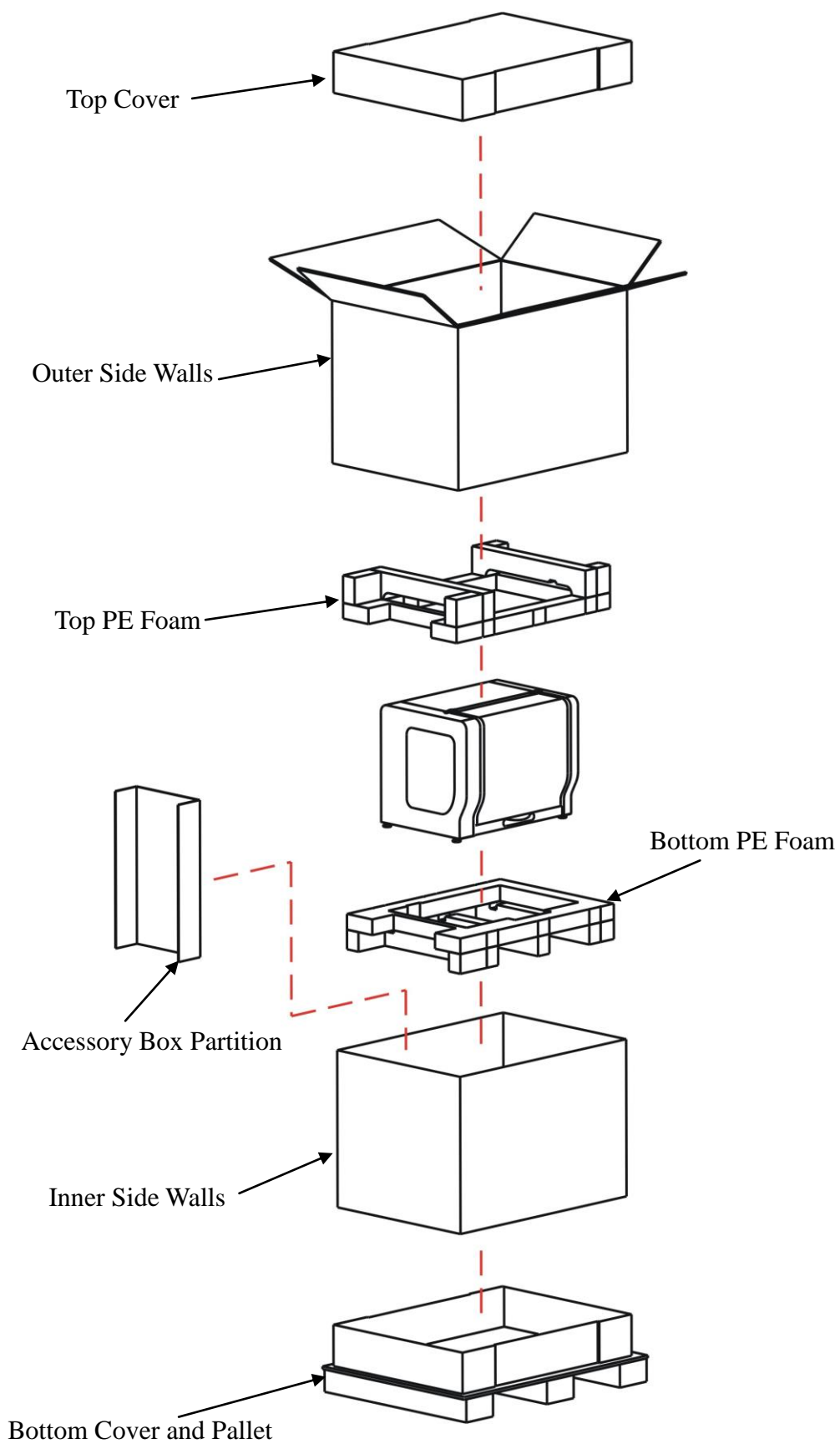

Figure 7. Unpacking of EzMate 401/601

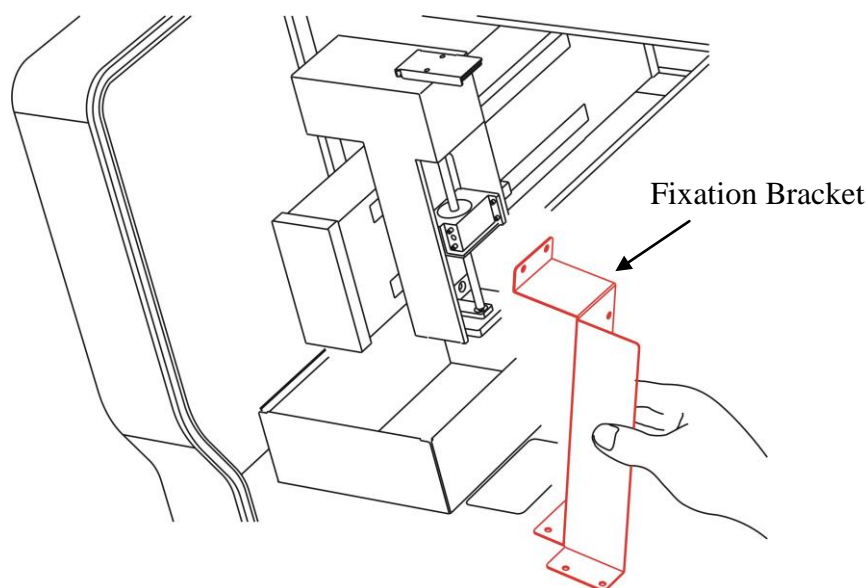

Figure 8. Removal the Fixation Bracket

3.2 Content List

Open the EzMate 401/601 Automated Pipetting System package and check that you have the following items:

1. EzMate 401/601 with one 1/8-channel, 50 μ l/200 μ l APM attached.
2. Operation manual x 1
3. Electric fuse (3.15A) x 1
4. AC power cord (US/EU/UK plug) x 1
5. Warranty card x 1
6. USB cable x 1
7. Notebook Computer x 1 (or higher performance model) with mouse
8. EzStarter control software DVD x 1 (including USB driver and others)
9. Disposable Used Tip Tray x 5
10. R1 Reagent Adapter x 1 (Option)
11. R2 Reagent Adapter x 1 (Option)
12. 96 well Plate Adapter (Option)
13. 384-well Plate Adapter (Option)
14. Tip Rack Adapter (Option)
15. Other optional items

If there are any missing, damaged, or incorrect items, please contact your distributor or sales representatives immediately. Other purchased optional items, such as adapters and accessories, might be included in the accessory boxes.

3.3 Instrument Installation

Before running EzMate 401/601, users are required to complete and confirm the simple hardware installations below. If these hardware installations are not implemented correctly, the APM module might not pick up the tips or liquid correctly and might collide with the labwares. This might damage the APM.

3.3.1 APM Installation and Removal

The interchangeable 4 Automated Pipetting Modules (APM) provide the flexibility and convenience. The standard EzMate 401/601 package is installed with one single channel 50µl/200µl APM. For different liquid handling applications, users can order additional APMs. The removal and installation of APM are simple and do not require any hand tools.

Please follow the steps below to remove the APM before exchanging a new one.

1. Power off EzMate 401/601 and Notebook Computer.
2. Unscrew the APM Fixation Screw (Please see Figure 9).
3. Hold the central section of APM around the metal Fixation Bracket.
4. Push the APM outward to your body.
5. Disconnect the Control Cable on top of the APM.

Docking Bracket (with 2 fixation pins in front and 2 fixation pins in rear)

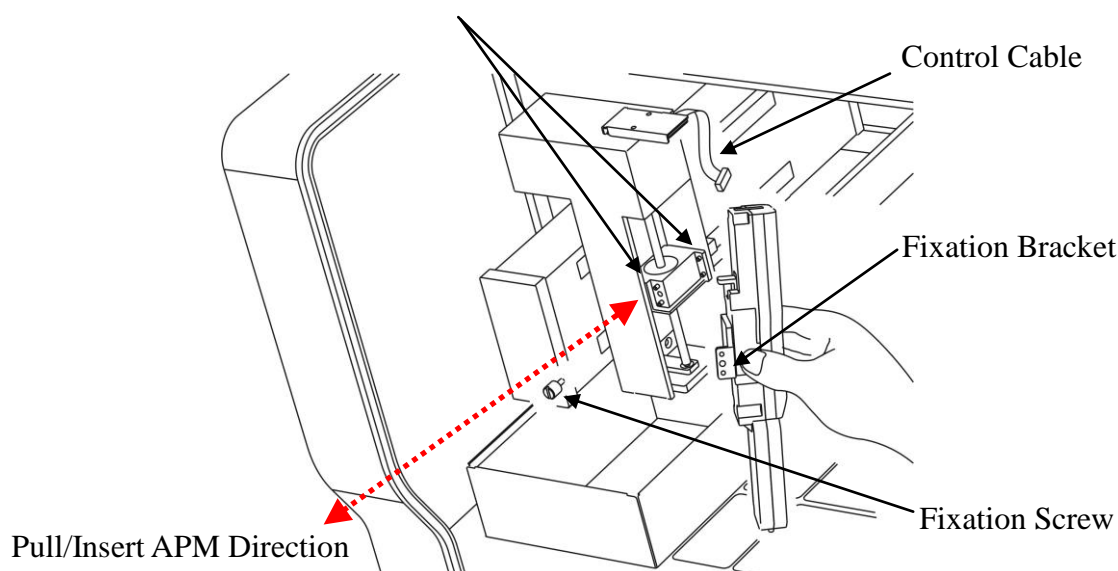

Figure 9. APM Installation and Removal

Follow these steps to install the APM:

1. Hold the central section of APM around the metal Fixation Bracket.
2. Slide and push the APM Fixation Bracket into the metal Docking Bracket of Z-axis. The holes of APM Fixation Bracket must connect with the one fixation pin in the front and two fixation pins in the rear of Docking Bracket of Z-axis firmly. Loosening the connection of these two brackets will affect the accuracy and precision.
3. Firmly screw in the fixation.
4. Connect the Control Cable at the top of the Z-axis to the APM. The connector of the Control Cable is directional.

3.3.2 Adapters Installation

There are currently 9 Adapters available for EzMate 401/601. Refer to section 2.2.4 for the applied labware products of these Adapters. Additional adapters will be available soon.

The worktable of EzMate 401 is divided into 6 Areas (A, B, C, D, R1, R2) through engraved lines and marks, while EzMate 601 has 8 Areas (A, B, C, D, E, F, R1, R2). These are positioning holes for the Adapter installation in these 6 Areas. To install the Adapters, insert the pins under the Adapters (96 tip rack adapter, R1 adapter and R2 adapter, etc.) or 4 rods around the Adapters (Elevated 96-well PCR plate adapter and Elevated 384well PCR plate adapter) to the positioning holes of these 6 Areas. The Adapters for R1 and R2 Area are directional, while the Adapters for A, B, C, and D are non-directional.

Note:

To ensure the correct positioning, no labware products should be placed on the worktable without the support of the Adapters.

3.3.3 Disposable Used Tip Tray Installation

A Disposable Used Tip Tray is placed on the left-hand side hollow section of the worktable. This Disposable Used Tip Tray can be removed by pulling it upward with the right and left-hand side of the tray. The hollow section of the worktable will position the Disposable Used Tip Tray correctly and prevent it from moving. The slot on the Tray Cover is used to prevent the sample or reagent from spilling when the ejected tips touch the bottom of the tray.

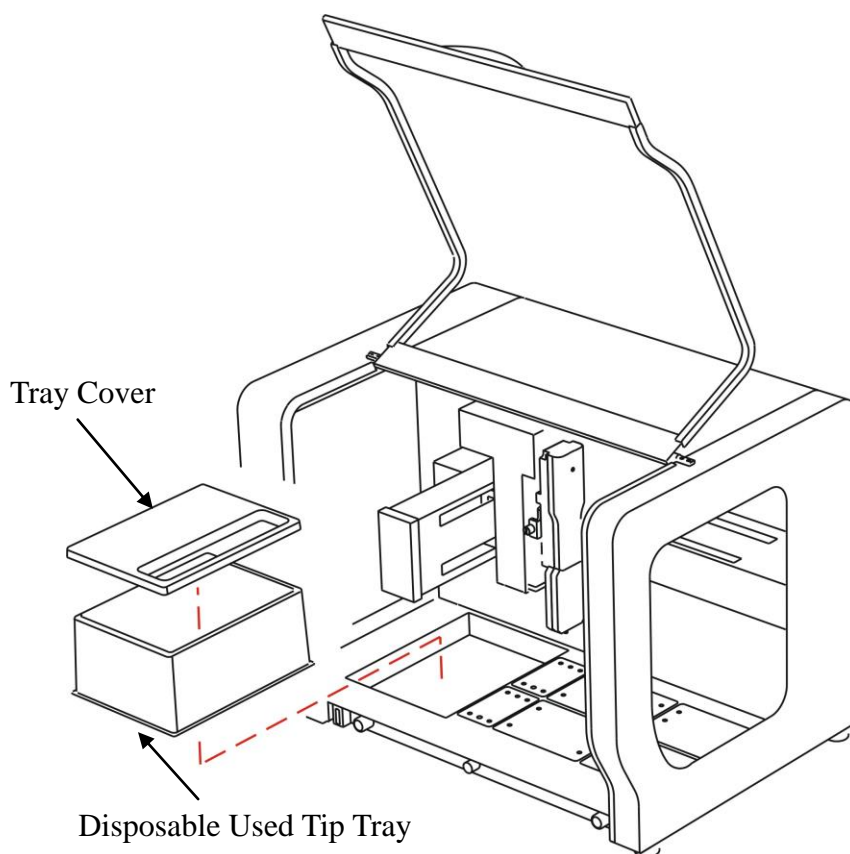

Figure 10. Used Tip Tray Installation and Removal

3.3.4 Computer Connection

The standard package includes a Notebook Computer with pre-installed Microsoft® Windows® 7 operating system or higher version and EzStarter. Follow these steps to connect the Notebook Computer and EzMate 401/601.

1. Connect the Type B connector of the USB cable to the USB socket in the rear of the EzMate 401/601.
2. Connect the Type A connector of the USB cable to any USB socket of Notebook Computer.

Note:

An USB driver is pre-installed in the Windows® 7 operating system.

3.4 Power On the Instrument

After the installing the EzMate 401/601, place the labware products, such as tip rack, plates, and tubes (with samples/reagents) on the Adapters.

Proceed with the following steps to turn on the instrument.

1. Power on the Notebook Computer.
2. Power on EzMate 401/601. The green indication light will be turn on and the Notebook Computer will automatically recognize the USB driver of the EzMate 401/601. The XYZ axes and APM will perform a calibration routine.
3. Double click the EzStarter  on the Windows® desktop to start the control software.
4. The initial screen (such as the one below) will appear and ask for account and password entry.
5. Key in the account name and password to login EzStarter. To access EzStarter, users can type in “User” as account name without entering a password.
6. The Administrator’s account name is “Admin” and the password is “0000”. For security purpose, users should change the Administrator password in the System/Account menu after initial log-in.

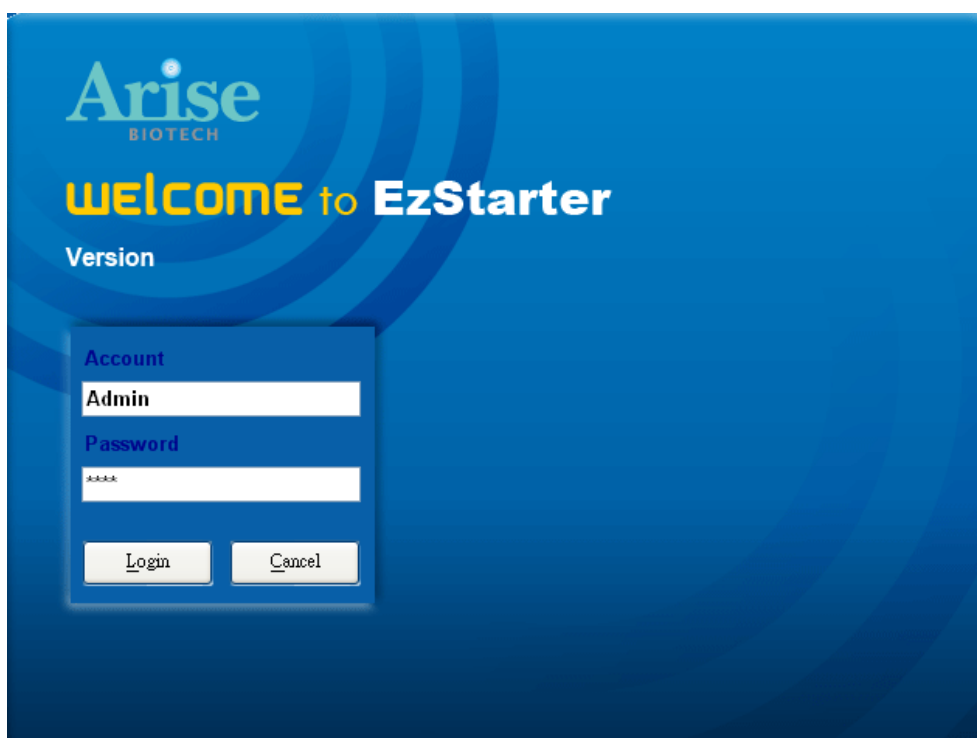

Note:

1. Account ID and password are case-sensitive.
2. If the Administrator password is lost, please call the authorized distributor for help.
3. If the lid is open when the EzMate 401/601 is on, calibration routine will not be performed and a warning beep sound will continue.

3.5 Starting EzStarter

Once users are in EzStarter, follow these steps to check the connection between the machine (APS) and APM.

1. A message window: “Apply APS and APM communication?” will appear. Press “OK” to perform the connection. “Done” will appear and press “OK” to continue.
2. Press “Cancel” to run EzStarter without controlling EzMate 401/601. The status bar in the lower-left corner of Worktab will display “System Offline”.

To run EzStarter, please refer to chapter 4 to 6 for more information and advanced settings.

3.6 Exiting and Shutting down

When users are done with the EzMate 401/601, exit EzStarter and shut down EzMate 401/601.

To exit EzStarter, select either Exit in the File menu or click “X” at the top right corner of the EzStarter worktab.

To shut down EzMate 401/601, switch off the Power Switch at the rear of EzMate 401/601. The green indication light of APM will be turned off at the same time.

4. Software

This chapter provides thorough information on the EzStarter. All elements shown in the protocol file (file format: *.aps) screen, such as the Menu, the Toolbar, the graphic Worktable section for labware selection, the Protocol section for writing a series of commands, the Property section for the information of APM and pipetting data and the Run section, are covered in this chapter.

4.1 Menu Map of EzStarter

EzStarter includes 7 menu: File, Edit, Protocol, Labware, Report, System, and Help, which are located at the top of the protocol file screen.

File Edit Protocol Labware Report System Help

Each menus include their own function and sub-menus. The structure is shown in Figure 11. Menu Map.

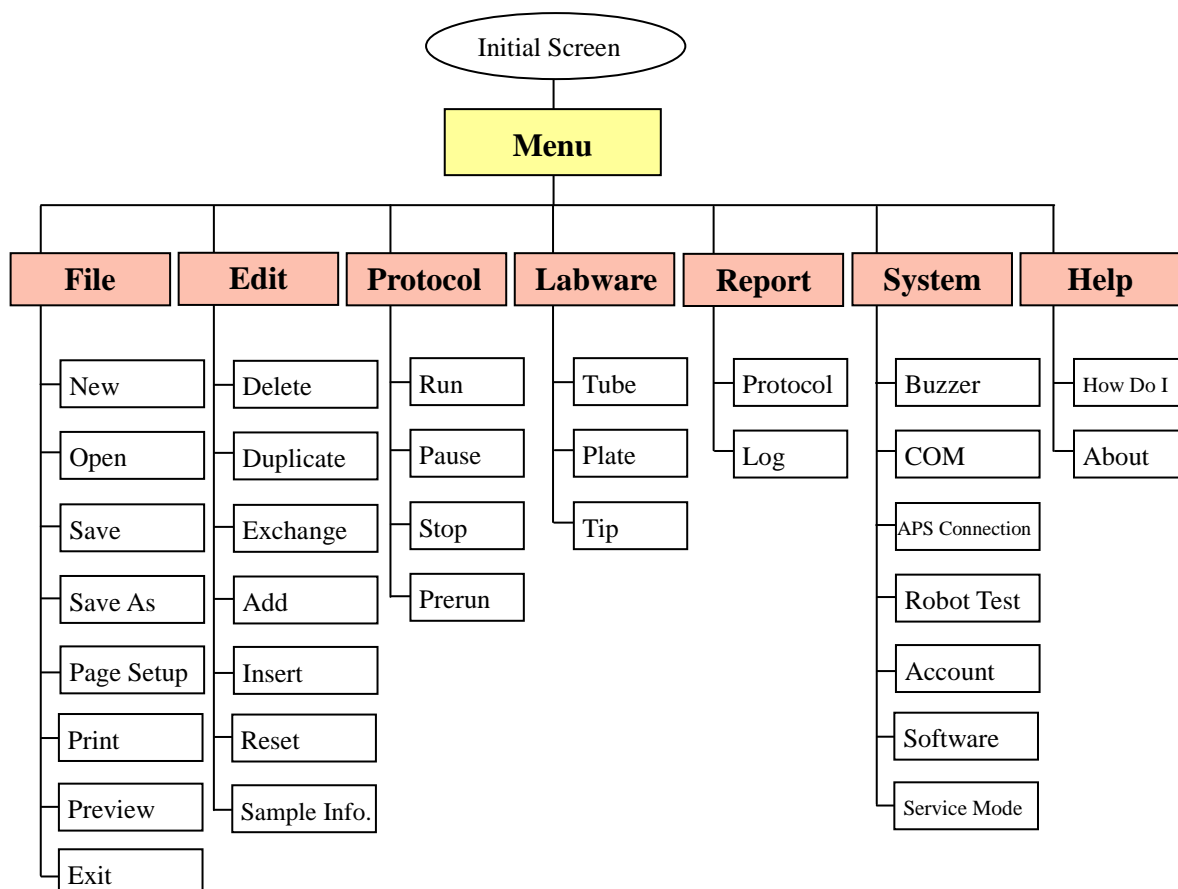
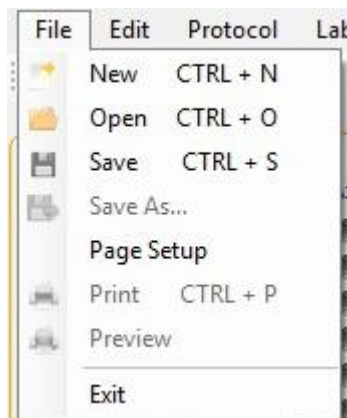

Figure 11. Menu Map

4.2 File

The File Menu gives access to a number of file related functions which can be accessed via the Toolbar.



New (Ctrl + N)

This option allows the users to create a new protocol file (file format: *.aps).

Open (Ctrl + O)

This option opens an existing protocol file that can be modified to create a new protocol file, or used as it is.

Save (Ctrl + S)

This option saves the current setup to a protocol file. All available parameters are saved.

Save As

This option saves the current setup to a new protocol file. Users can modify an existing protocol and save as a new file name.

Page Setup

This option allows users to configure various options (size, margins, page orientation) related for print out.

Print (Ctrl + P)

This option allows users to print the current protocol file's Protocol Report which includes the selected labwares, commands, property, and so on.

Preview

This option allows users to preview the printing.

Exit

This option allows users to close the software.

4.3 Edit

The Edit Menu allows users to create and modify the running protocol commands. All functions in the Edit Menu can also be accessed by right clicking the mouse button on the command tab.

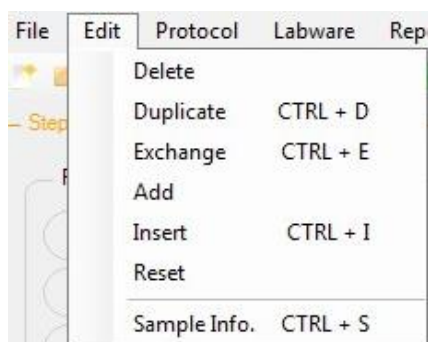
**Delete**

This option allows users to remove a selected command.

Duplicate (Ctrl + D)

This option allows users to copy a selected command.

Exchange (Ctrl + E)

This option allows users to exchange a selected command.

Add

This option allows users to add a new command.

Insert (Ctrl + I)

This option allows users to insert a new command.

Reset

This option allows users to empty the source and destination setting of a selected command.

Sample Information (Ctrl + S)

Clicking Total View in the Sample Information window will display all the selected wells. Users can key in each wells' information in Sample Information window, and print the sample information under the Protocol Report (4.6.1).

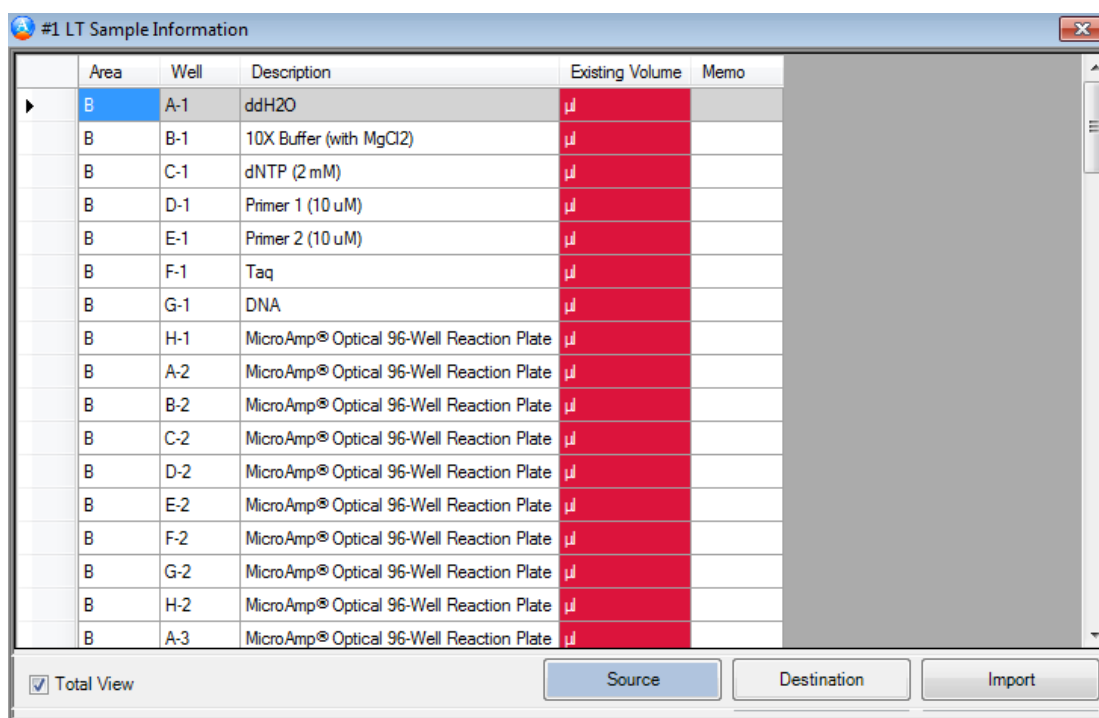

4.4 Protocol

The Protocol Menu allows the operation of current protocol files. Some functions in the Protocol Menu can also be accessed via the Toolbar.

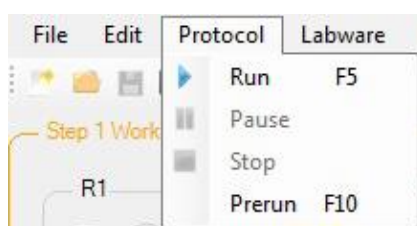

Run (F5)

This option allows users to run a protocol.

Pause

This option allows users to pause the protocol.

Stop

This option allows users to abort the protocol.

Prerun (F10)

This option allows users to simulate the running process.

4.5 Labware

There are three sub-categories in the Labware menu: Tube, Plate and Tip. EzStarter is pre-installed with the labware database for commonly used disposable robot tips, storage tubes/reagent vessels and 1 x 8 microstrips /96-well/384-well microplates.

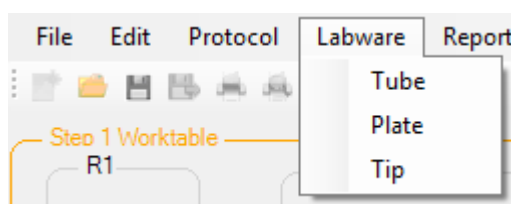

4.5.1 Enable the Tubes in worktable

Under the Labware Tube window, check the “Enabled” box for the selected tube and the boxes of the adapters to be used with the tube, then click the “Save” button to save the settings. Close the Labware Tube window to go back to the EzStarter window.

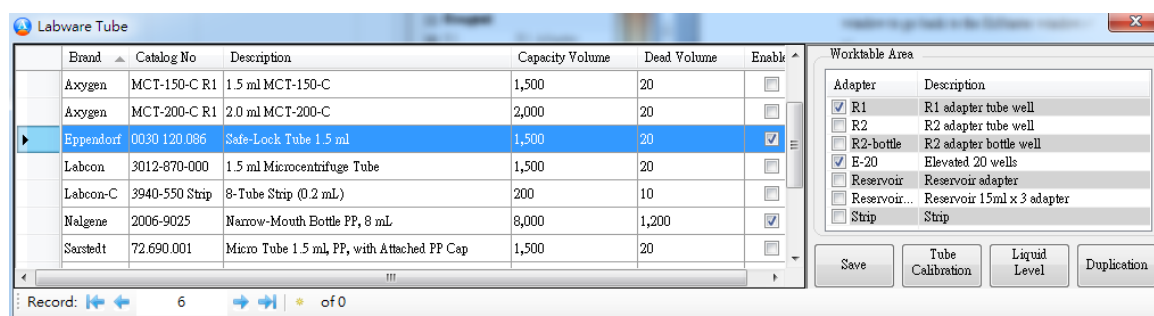

4.5.2 Enable the Plates in worktable

Please refer to Section 4.5.1 to enable the plates in the worktable, and also check the workable areas for the plates (Area A/B/C in EzMate 401, Area A/B/C/D/E in EzMate 601).

4.5.3 Enable the Tips in worktable

Please refer to Section 4.5.1 to Enable the tips in the worktable.

4.6 Report

The Report Menu allows users to review a protocol report and log records.



• Protocol

This option allows users to review a summary of the protocol parameters and reactions configuration.

• Log

This option allows users to review actions that have occurred during system operation.

4.6.1 Protocol Report

Click the Protocol option under Report Menu. The opened “Protocol Report” contains the run set up with the following information on:

- The protocol name, description and saving location.
- Automated pipetting module (APM) information
- All commands settings including Source, Destination, Pipetting Volume, Pipetting Speed, Mixing etc.
- Tip information including brand, type, capacity volume and the amount required during the run.
- Labware configuration, brand, location and the amount of reagent required during the run.
- The current time and date.
- Software version

Protocol Report

Name: Arise
 Description: Actin
 Memo: Housekeeping gene
 APM Define: 1 Channel 50 µl
 File Name: C:\Test_1.apr

#1 LT	Source(2)	Destination(2)	Volume(µl)	Options
	R2(R2-7)	B(H-1)	25µl	Aspiration: Under Liquid Level
	R1(R1-4)	B(E-12)		Aspiration Speed: 1 Dispense Speed: 1 Mix: No Tip Change Before Each Aspiration
#2 MD	Source(1)	Destination(3)	Volume(µl)	Options
	R2(R2-7)	A(O-3)	2µl	Aspiration: Under Liquid Level
		A(H-10)		Aspiration Speed: 1
		A(O-23)		Dispense Speed: 1 Mix: No Tip Change Before Each Aspiration Reverse 2µl

Tip Usage

Name	Description	Capacity	Volume	Usage
EzTip 50µl Non-filtered	50 ul w/o filter, Non-Sterile	50µl		3

Area A: Roche 384 047729749001

Well#	Description	Capacity	Volume	Required Volume	Add Volume
O-3	LightCycler® 480 Multiwell Plates 38	20µl		µl	2µl
H-10	LightCycler® 480 Multiwell Plates 38	20µl		µl	2µl
O-23	LightCycler® 480 Multiwell Plates 38	20µl		µl	2µl

Area B: ABI 96 N8010560

Well#	Description	Capacity	Volume	Required Volume	Add Volume
H-1	Sample 1	200µl		µl	25µl
E-12	MicroAmp® Optical 96-Well Reactio	200µl		µl	25µl

Area R1

Well#	Name	Description	Capacity	Volume	Required Volume	Add Volume
R1-4	Eppendorf 0030 1	Safe-Lock Tube 1.5 ml	1500µl		25µl	µl

Area R2

Well#	Name	Description	Capacity	Volume	Required Volume	Add Volume
R2-7	Nalgene 2006-90	Buffer	5000µl		33µl	µl

4.6.2 Log Report

The log report records every step of a run. Users can tick off “Log” on the System Menu (System/Software/Log). A log will be automatically generated when every protocol is started. Please note that the log will be automatically saved in the EzMate file (C:\Document\EzMate).

To review the log report, proceed as follows.

- Open the protocol for the corresponding log that you want to review.
- Click the Log option of Report Menu to display the log record.

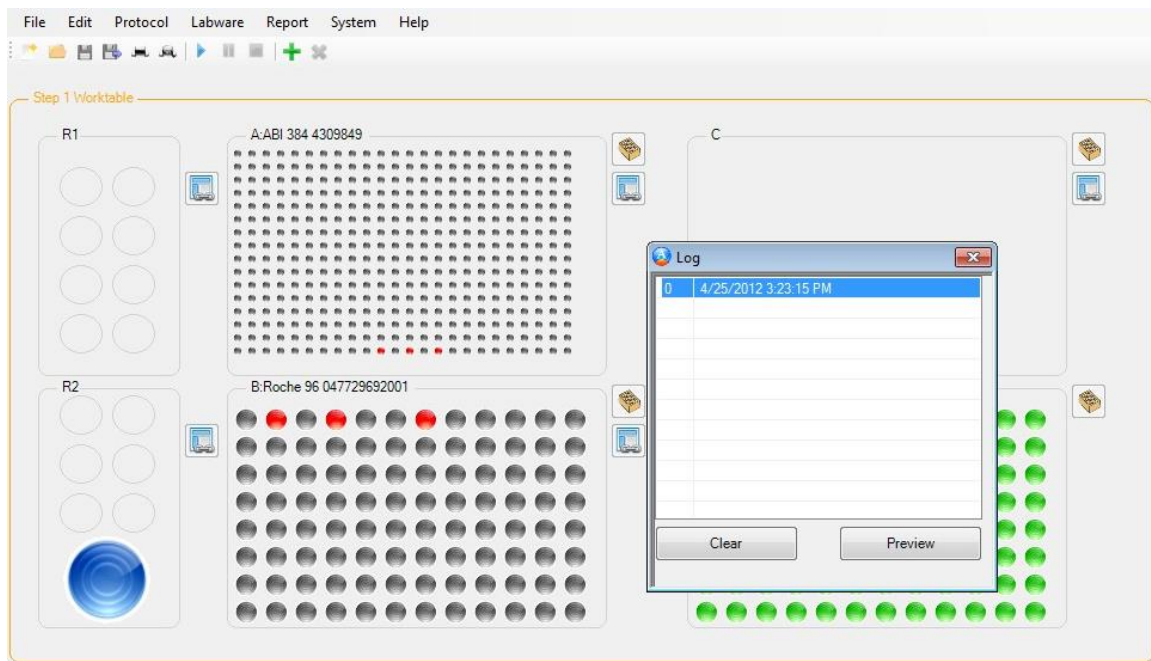

- Select a log that you want to review.

Log Report

Time	Action
C:\test_1.apr	
APM 1C 50 µl	
2011/08/26 10:50:54	
10:50:54	APS Initial
10:51:10	Drop tip
10:51:20	Pick tip
10:51:23	Move to R2-7 of R2 area
10:51:26	LT Aspirate Volume: 25µl
10:51:29	Move to H-1 of B area
10:51:32	LT Dispense Volume: 25µl
10:51:37	Drop tip
10:51:42	Pick tip
10:51:45	Move to R1-4 of R1 area
10:51:48	LT Aspirate Volume: 25µl
10:51:51	Move to E-12 of B area
10:51:54	LT Dispense Volume: 25µl
10:52:00	Drop tip
10:52:00	Out of Tip !!
10:52:06	APS Continue
10:52:11	Pick tip
10:52:14	Move to R2-7 of R2 area
10:52:16	MD Aspirate Volume: 2µl x 3 Reverse: 2.0µl
10:52:19	Move to O-3 of A area
10:52:20	MD Dispense Volume: 2µl
10:52:21	Move to H-10 of A area
10:52:22	MD Dispense Volume: 2µl
10:52:24	Move to O-23 of A area
10:52:26	MD Dispense Volume: 2µl
10:52:26	Protocol finish drop tip
10:52:40	Total running time:00:02:32
2011/08/26 10:52:40	

4.7 System

This section describes the EzStarter software system set up. There are seven sub-categories: Buzzer, COM, APS Connection, Robot Test, Account, Software and Service Mode in the System menu. Service Mode is only for administrator purpose.

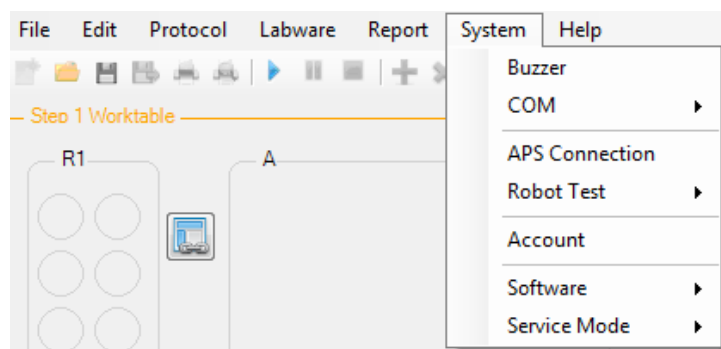

4.7.1 Buzzer

When you select the Buzzer, APS will sound under the following situation:

1. Run the protocol and pause the APS.
2. Run the protocol and open the safety door.
3. Run the protocol and when there are not enough tips.
4. APM Time Out (Connection time out error, please see Troubleshooting code 2001).

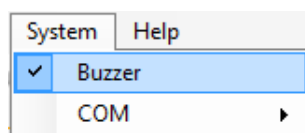

4.7.2 COM

COM is the communication port.

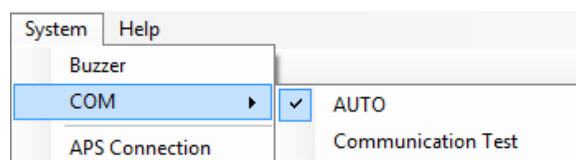

• Auto

When the computer is connected with APS through the USB, the computer will auto search a COM port to connect with APS and records the COM port in the computer.

• Communication Test

This function is to test the communication between APS and computer. You can key in a number in Run Times and click Run to start the Communication Test. The Result will display OK upon completion. If communication fails, “APS NOT AVAILABLE” message will be displayed (please see Troubleshooting).

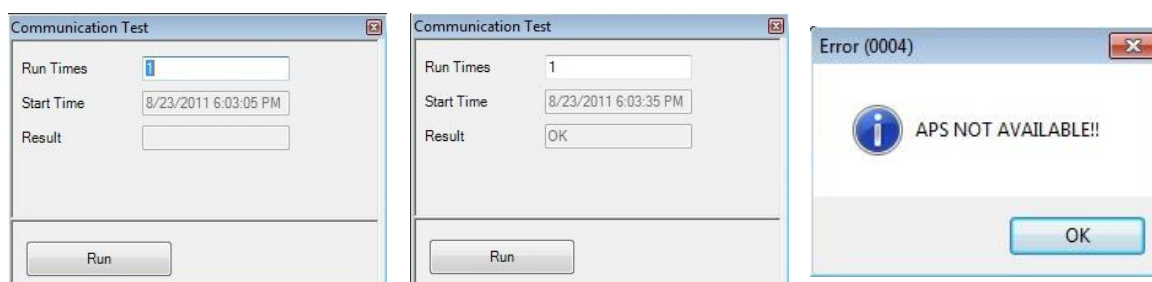

4.7.3 APS Connection

You can use this function to check the APS connection. In the “Apply APS connection?” window, click **OK** and the APS connection will display “Done” or an “APS NOT AVAILABLE” will be displayed (please see Troubleshooting).

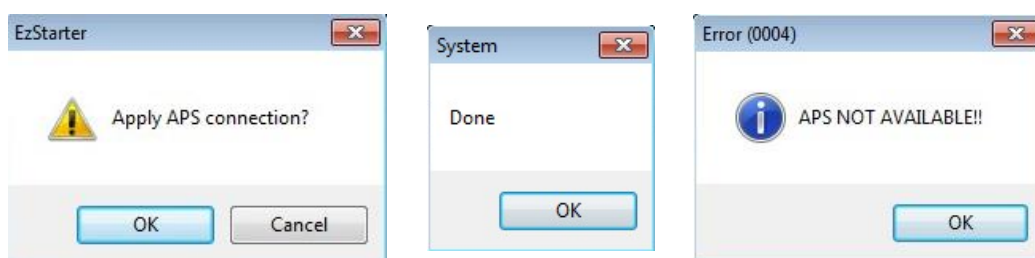

4.7.4 Robot Test

Users can use Robot Test to confirm the basic APS function. There are 3 items: Axes Test, Self Run Test and Leakage Test in the Robot Test.

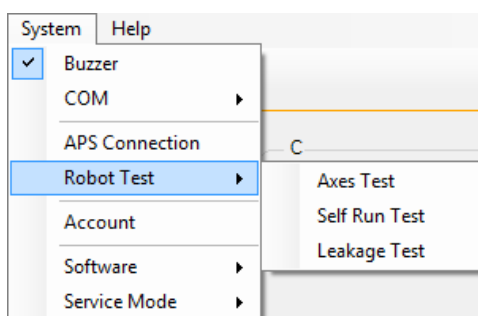

• Axes Test

This is to check the precision of APM X, Y and Z axes. When you choose Axes Test and key in a number in Run Times by clicking **Run**, the APM will run X, Y and Z axes. The computer will verify if the steps are correct or not. The Result will either display PASSED or FAILED (If failed, please contact your agency).

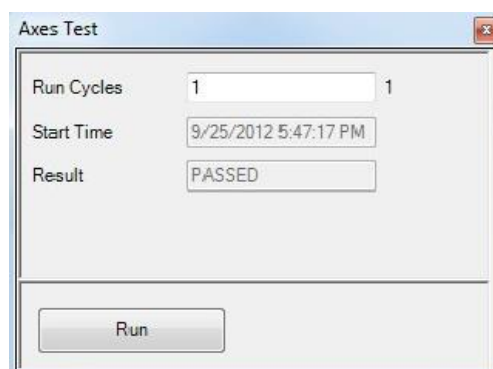

• Self Run Test

You can do an APM self run test before you run the protocol. In the Self Run Test, you can key in a number in Run Times then click **Run**. The APM will run the adapter calibration point of six areas. After Self Run Test, the Result will either display PASSED or FAILED (If failed, please contact your agency).

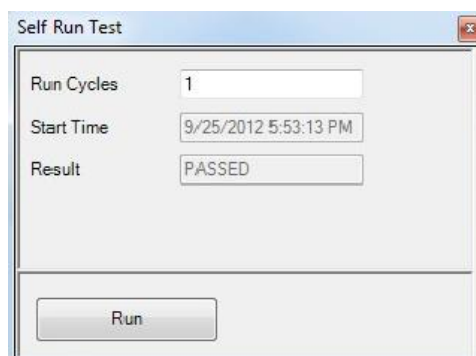

• Leakage Test

Users can use this method to do a tip leakage test.

Leakage test step:

- First click on **Tip Selection** and **Plate Selection** to choose labwares, and then put tip rack and 96-well plate on the D and B areas, respectively.

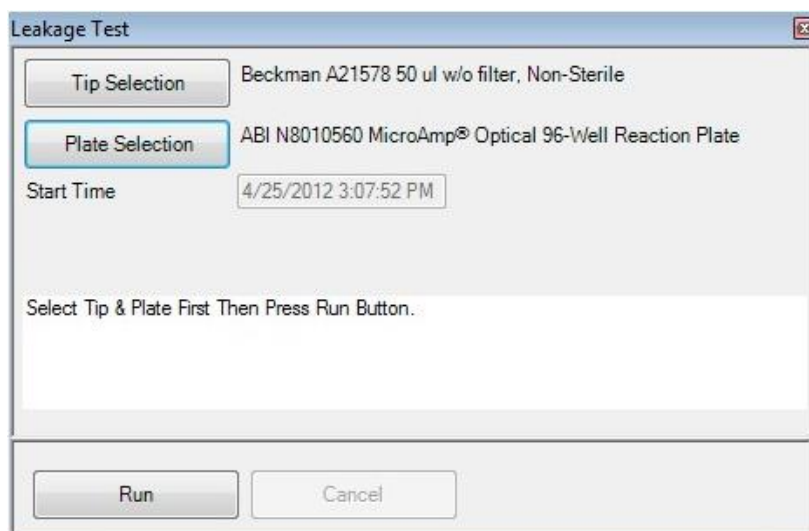

- For the 96-well plate, users will need to load enough water with dye (ex. Bromophenol blue or Orange G) into H-1 (1 channel) 1 well or A-1 to H-1 (8 channel) 8 wells for the leakage test.

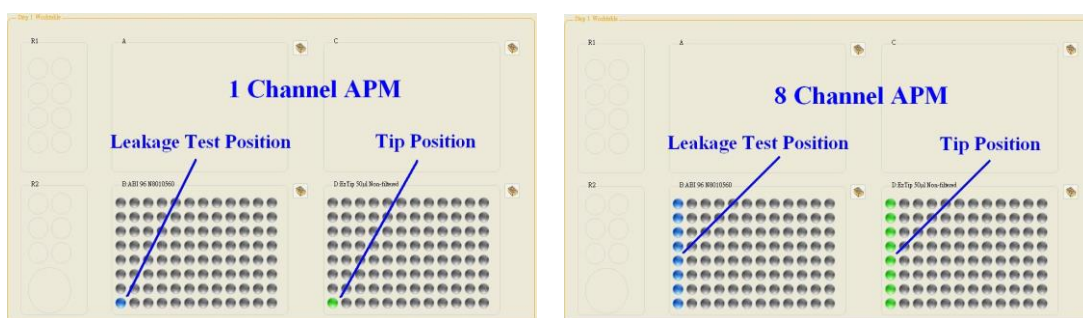

- Click **Next** sequentially to finish the leakage test.
 1. Click **Next** ⇒ APM will proceed to D area.
 2. Click **Next** ⇒ APM will fit the tip.
 3. Click **Next** ⇒ APM will proceed to B area.
 4. Click **Next** ⇒ APM aspirates 80% volume of liquid (ex. 50µl APM aspirates 40µl liquid, 200µl APM aspirates 160µl liquid), and then draw a line on the tip with the top of liquid.
 5. Click **Next** ⇒ Leakage Test window will lock the **Next** button for 1 minute, and after 1 minute if the liquid level descends less than 0.5cm of the total liquid level, then the leakage test has passed. If the liquid level descends more than 0.5cm of the total liquid level, then the leakage test has failed. (If failed, please contact your agency).
 6. Click **Next** ⇒ APM dispenses liquid.
 7. Click **Next** ⇒ APM drops the tip.

8. You can click **Next** to proceed with the leakage test again or click “Close button (X)” to finish the test.

Note:

Click **Cancel** and “Close button (X)” to leave the Leakage Test window at any time.

4.7.5 Account

Only administrators can modify the account. Under Account Administration, administrators can either add or delete accounts. Administrators can add a new account by typing in the account name and the information on the last row that has a “*” symbol. Administrators can delete an account and the information by first selecting the account and pressing the “Del” button on the keyboard. If the Administrator changes and forgets its password, please contact the Authorized Distributor for help. The Administrator can add a new account, only when the End-user group is selected in the Function block.

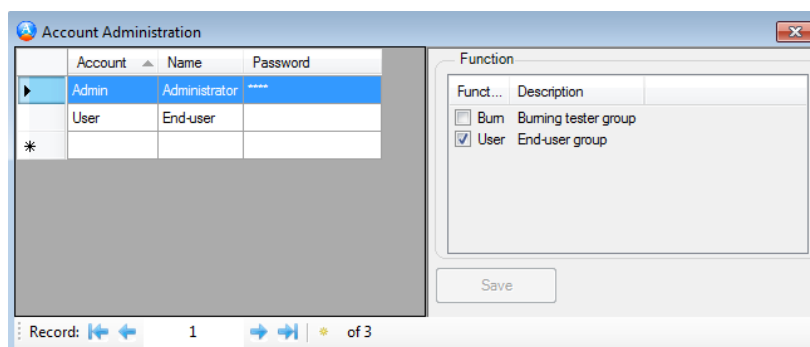

4.7.6 Software

There are seven items: Hint, Recently File Open, Finish Aphorism, Log, Labware Grid Lines, Command Auto Check and Database in the Software menu. These functions are described below.

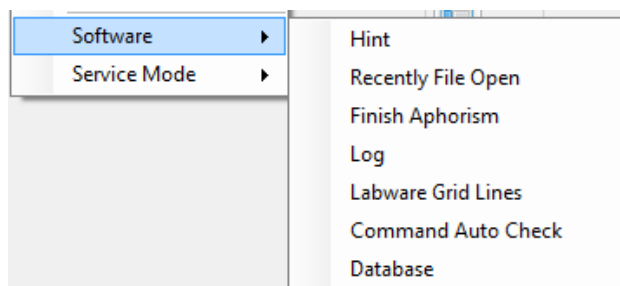

● **Hint**

When users select the labware, and move the cursor to this labware, the labware information will be displayed.

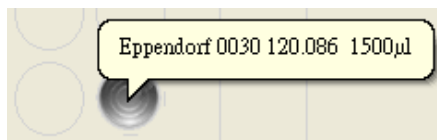

● **Recently File Open**

When users open the EzStarter software, it will also open the file that was used last time.

● **Finish Aphorism**

When the protocol is finished, the Run Information message will show and an ending tune will sound.

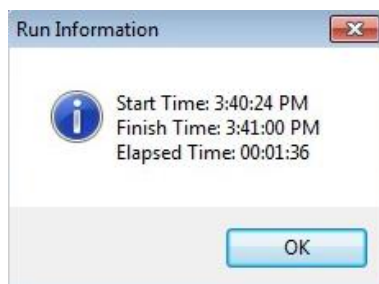

● **Log**

EzStarter software will record every step of a run. Please see 4.6.2 Log Report.

● **Labware Grid Lines**

It will add grids on the labwares at A, B, C and D areas.

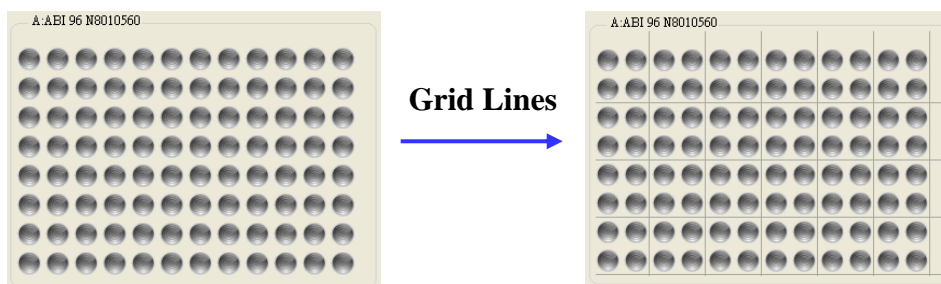

• Labware Indicator

This function will add labels around your selected labwares.

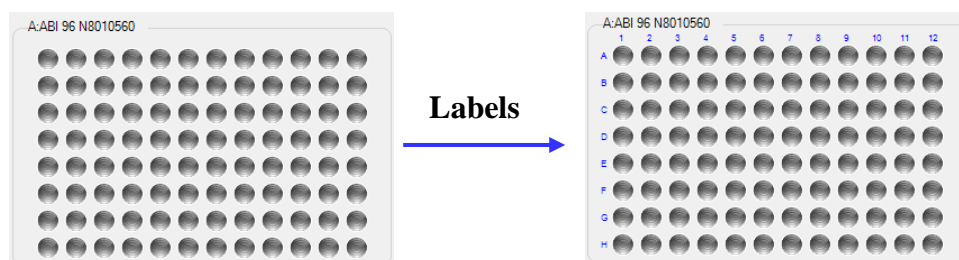

• Command Auto Check

When users set a new protocol and add a new command, without selecting the source or destination, the software will remind users to select them.



• Database

This function is to export and import labware raw data to other computers. The Update and Restore functions are for importing data. Update will add new labware raw data to EzStarter, and Restore is to replace with new labware raw data.

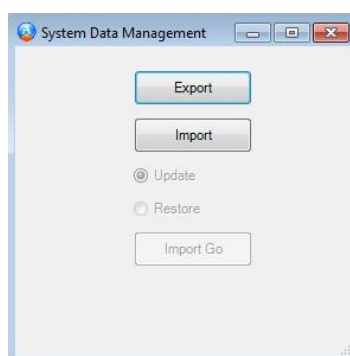

4.7.7 Maintenance Aphorism

APS and APM have maintenance time.

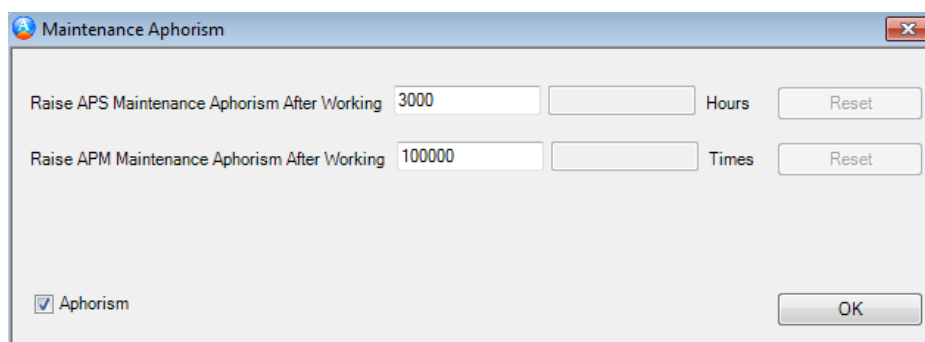

4.8 Help

EzMate 401/601 help information is available in the Help Menu.

4.8.1 How Do I

The operation manual will guide users in using EzMate 401/601.

4.8.2 About

Displays information about the EzMate 401/601 Software, APS and APM.

5. Work Tab Overview

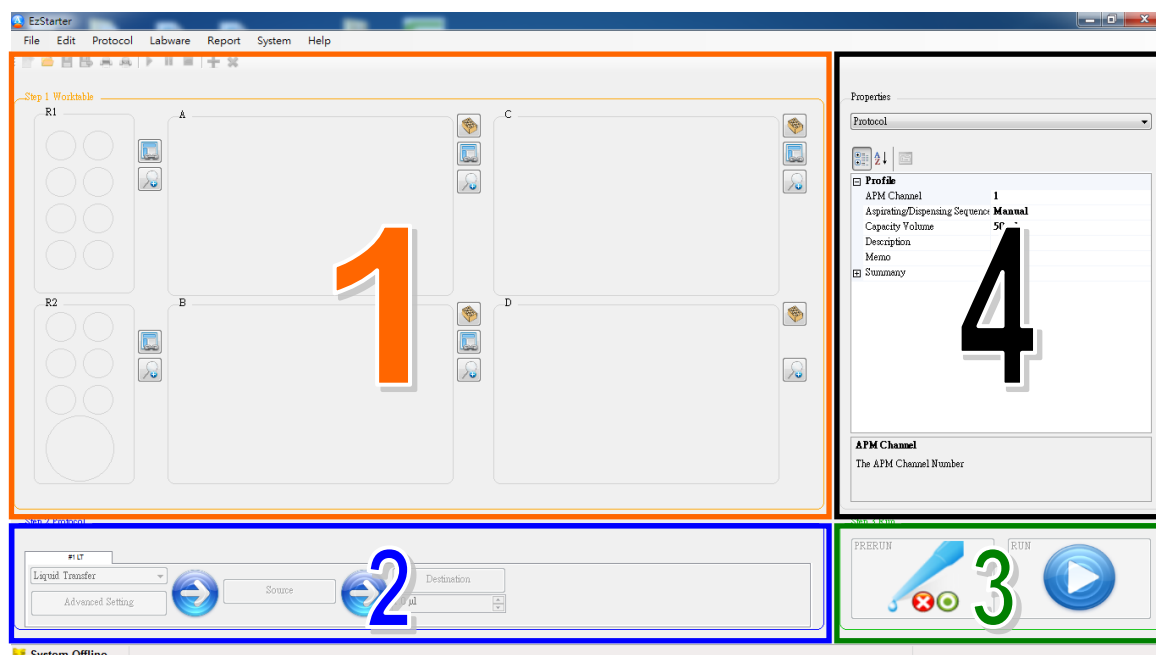

The **Worktable** (section 1) is displayed on the top left section of the main window. Labwares can be defined on the worktable via the mouse.

The **Protocol List** (section 2) is displayed on the bottom left section of the main window. It shows all commands and the parameters for each command.

The **Pre-Run and Run section** (section 3) is displayed on the bottom right section of the main window. You can pre-run or run your protocol.













The **Properties section** (section 4) is displayed on the top right section of the main window, and contains general information on the system.

5.1 Icons in the Work Tab for EzMate 401/601

Toolbar

The Toolbar allows easy access to and exposes some of the main functions in the software. These are described here.



Icon	Description	Function
	New Protocol	To create a new protocol file.
	Open Protocol	Allows you to select and open an existing protocol file
	Save Protocol	To save the current running protocol as a *.aps protocol file.
	Save to New Protocol	Save as the current running protocol to a new protocol file.
	Print	To print a protocol file..
	Preview	To preview the printing.
	Run	To run a protocol file.
	Pause	During a run, click on this icon to pause the run. Click on the icon  to resume the run.
	Stop All	During a run, click on this icon to abort the run
	Add	Add a new command in the protocol
	Delete	Delete a command in the protocol

5.2 Worktable

Worktable is designed for labware settings.

- **EzMate 401/601 has six/eight areas A, B, C, D (plus E, F for 601), R1 and R2 in worktable.**

Area	Adapter	Labware
A, B, C (A, B,C, D, E for 601)	<ul style="list-style-type: none"> ● 96-well adapter ● 384-well adapter ● 20-well adapter ● Deep well adapter ● Terasaki tray adapter ● 96-well conical adapter ● ELISA/Cell culture adapter ● Illumina adapter 	<ul style="list-style-type: none"> ● 8-tubes PCR strip ● 96-well PCR plate ● 384-well PCR plate ● 1.5ml tube ● 2ml tube ● Deep well plate ● Terasaki tray ● 6~384-well ELISA/Cell culture plate ● Illumina 48-well PCR plate
C, D (C, D, E, F for 601)	<ul style="list-style-type: none"> ● Tip rack adapter 	<ul style="list-style-type: none"> ● 50µl and 200µl tip racks

Area	Adapter	Labware
R1	<ul style="list-style-type: none"> ● R1 adapter ● R2 adapter ● Reservoir adapter ● 3x 8-strips adapter 	<ul style="list-style-type: none"> ● 1.5ml, 2ml tube ● 5ml bottle ● 80ml reservoir ● 15ml reservoir ● 8-tubes PCR strip
R2	<ul style="list-style-type: none"> ● R1 adapter ● R2 adapter ● Reservoir adapter ● 3x 8-strips adapter 	<ul style="list-style-type: none"> ● 1.5ml, 2ml tube ● 5ml bottle ● 80ml reservoir ● 15ml reservoir ● 8-tubes PCR strip

1. A, B, C (A, B, C, D and E for 601) areas are for SBS format microplate, 20-well, deep well plate, Terasaki tray, ELISA/Cell culter plate and Ilminar plate adapters.
2. C, D (C, D, E and F for 601) areas are for tip rack adapters.
3. R1 and R2 areas are for 1.5ml/2ml tube adapter, 2ml tube/5ml bottle adapter, 80ml reservoir adapter, 3 x 15ml reservoir adapter and 3 x 8-strip adapter.

5.3 Protocol List

The protocol list shows all commands on the worktable. There are six commands; Liquid Transfer, Multiple Dispenses, Serial Dilution, Hold, Mixing and Loop.

5.4 Pre-Run and Run

When you set up a new protocol or open a protocol file. You can click PRERUN to check if the protocol is correct or not, then click RUN to test.

5.5 Properties

Properties section shows Worktable and Protocol information.

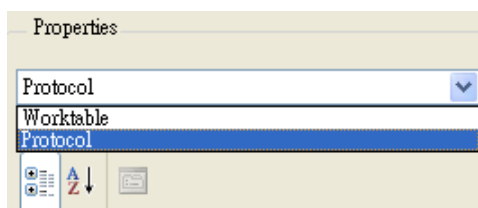

Worktable

Displays Worktable information, such as labware vendor and model. Users can activate 20-well adapters and reservoir adapters in the Properties/Worktable before select any labwares in the Step1 Worktable. To activate reservoir adapters and 20-well adapters, please see section 6.2.1 Reagent Area (R1 and R2) and section 6.2.2 Worktable Area (A/B/C for EzMate 401, A/B/C/D/E for EzMate 601).

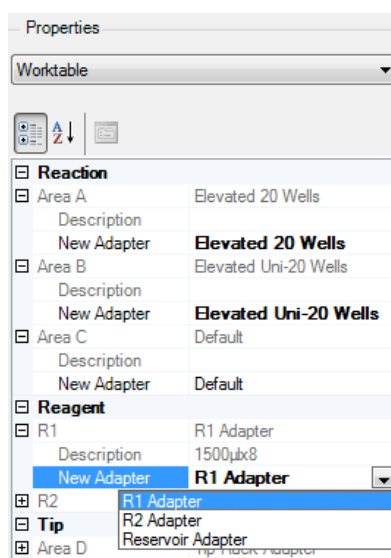

Protocol

Displays Protocol information. Users can key in Description and Memo information in the Profile. This information will be saved inside the protocol file.

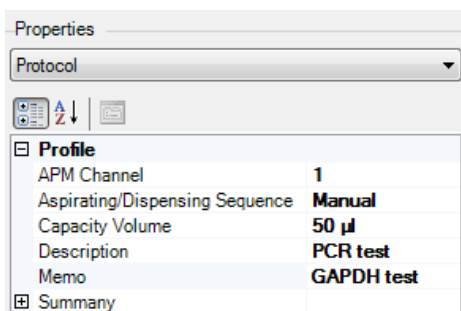

6. Operation

Operating the EzStarter is as easy as 1-2-3. Users only need to follow Step 1-2-3 shown on the screen to create, pre-run and run a new or existing protocol file. To prepare your protocol file, first select the labwares for the Areas (R1/R2/A/B/C/D for EzMate 401, R1/R2/A/B/C/D/E/F for EzMate 601) in the “Step 1 Worktable” section (Section 1). Then prepare your commands in the “Step 2 Protocol” section (Section 2). Lastly, pre-run or run the protocol in the “Step 3 Run” section.

6.1 Create A New Protocol

Double-click the **Arise EzStarter icon** on the desktop. Once **EzStarter** boots, the login screen will appear. Enter the account name and password, and click Login. **EzStarter** will start a new protocol file screen such as this:

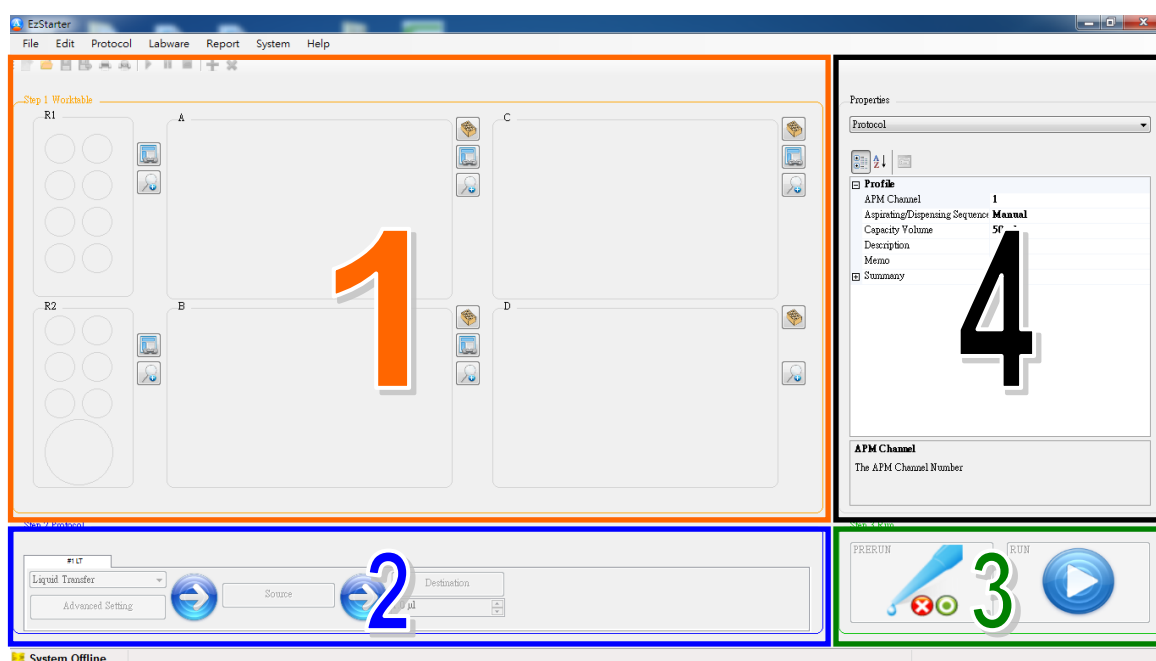

Note:

A new protocol file (Format: *.aps) should include the labware information, a protocol (a series of commands) and the properties information.

6.2 Selecting the Labwares

Select the labwares after starting a new protocol file. Please follow the section below to select the labwares for different areas on the worktable. Once the labwares are selected, the selected labwares and its positions will apply to all commands.

6.2.1 Reagent Area (R1 and R2)

1. Users can left-click  icon on Worktable to choose proper Adapter in the Step1 Worktable.

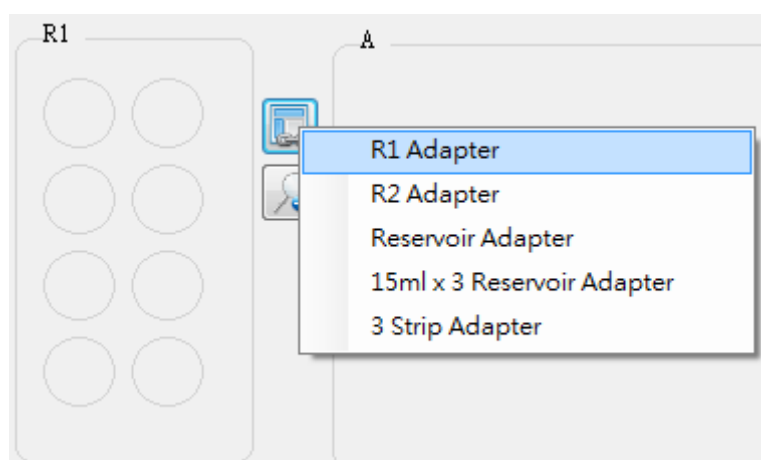

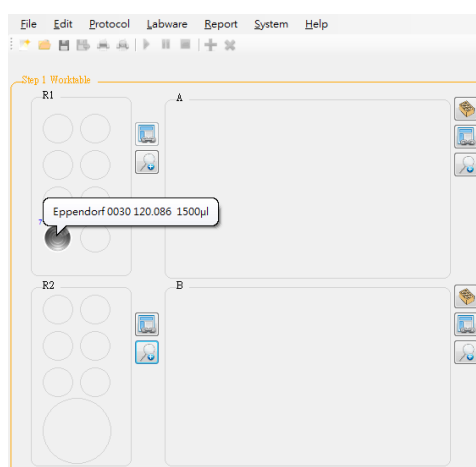
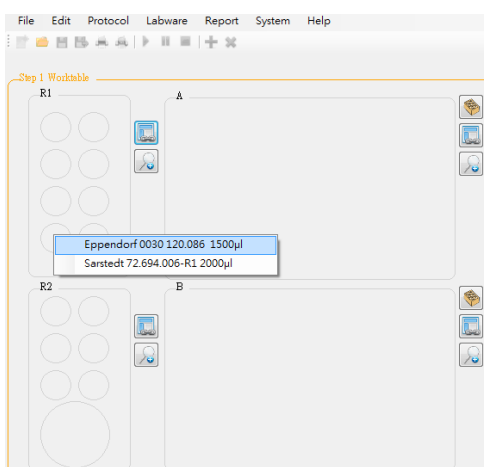

2. Left-click on the **Reagent Area R1** location. The available tube/reservoir list will be displayed.
3. Select the tube/reservoir you want to position on the Reagent Area R1. The selected position will be highlighted in gray.



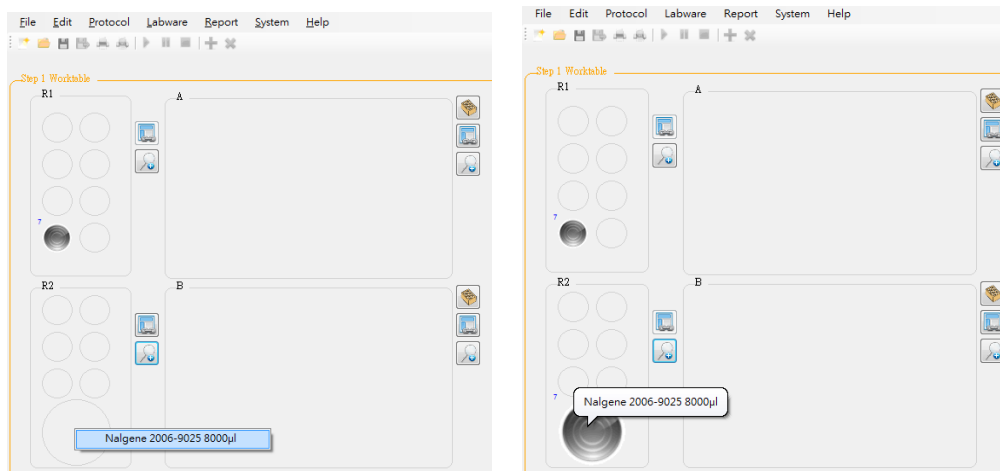

- Repeat steps 1 and 2 to select the Labwares for the other positions on the Reagent Area R2.

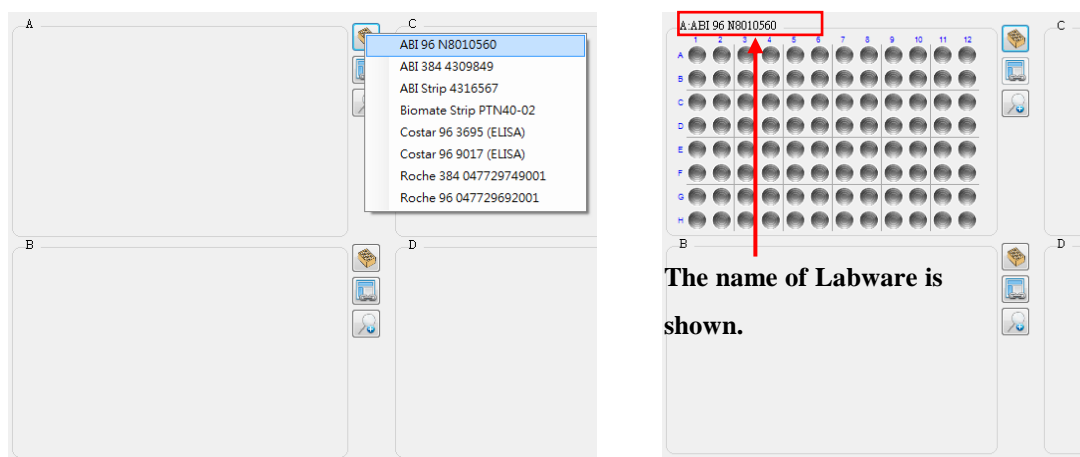

6.2.2 Worktable Area (A/B/C for EzMate 401, A/B/C/D/E for EzMate 601)

- If users want to use 96 well or 384 well microplate, left-click on the  icon at the upper right hand corner of the Area A and B without choosing  icon. The available microplate list is displayed.
- Select the microplate (96 well or 384 well) you want to position on the Area A and B. The selected location is highlighted in gray and the name of the selected item is shown on the upper left-hand side of Area A and B.



3. If users want to use labwares with special adapter, they need to click Special Adapter icon () on Area A and B to choose one of the special adapter before selecting any labwares.



4. Left-click on the worktable area, and the available vessel list will be displayed.
5. Select the vessel you want to position on the area. The selected position will be highlighted in gray.

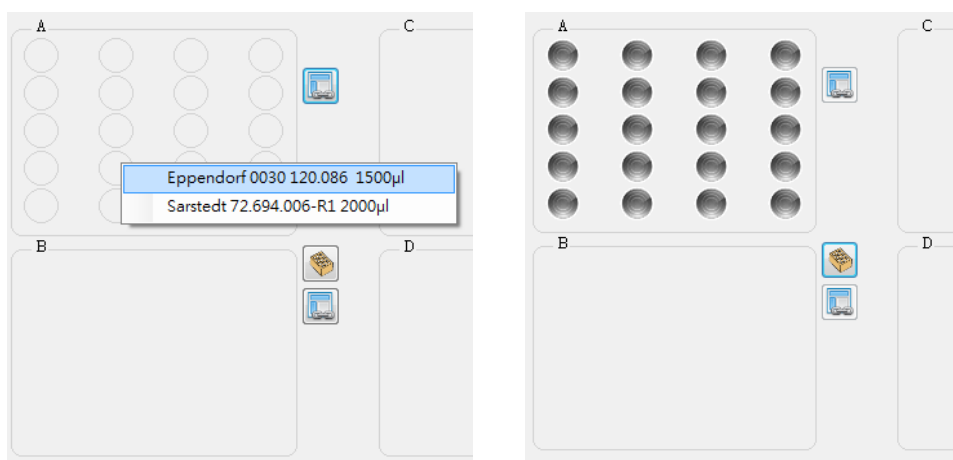

6. Area C (EzMate 401) or Area C/D/E (EzMate 601) are designed for both vessels and tips. Its labware list includes available microplates, tubes and tips. Repeat steps 1 ~ 5 to assign vessels to these areas. Refer to following Section 6.2.3 if you want to use tips on these areas.

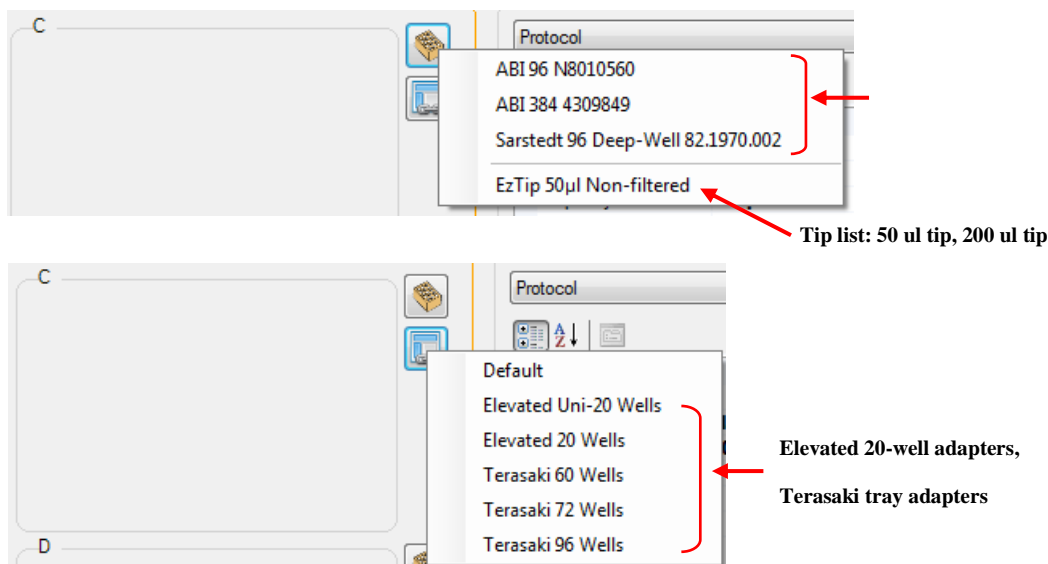

6.2.3 Worktable Area (D for EzMate 401, F for EzMate 601)

1. Left-click the icon on the upper right-hand corner of Area D (EzMate 401) or Area F (EzMate 601). The available Tip list is displayed.
2. Select the tip you want to position on Area D (EzMate 401) or Area F (EzMate 601). The selected location is highlighted in gray and the name of selected item is shown on the upper left-hand corner of Area D (EzMate 401) or Area F (EzMate 601).

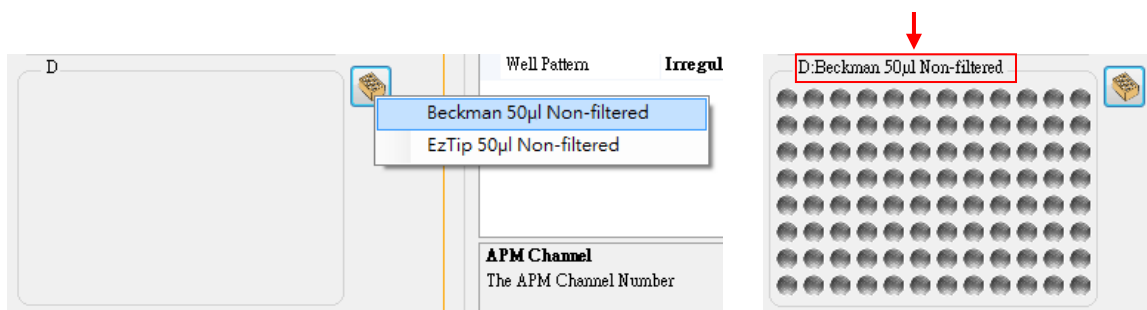

6.2.4 Removing labwares from Area

1. Right-click on the labware you want to delete.
2. Select **Remove** from the context menu.
3. The gray labware icon is removed from t.

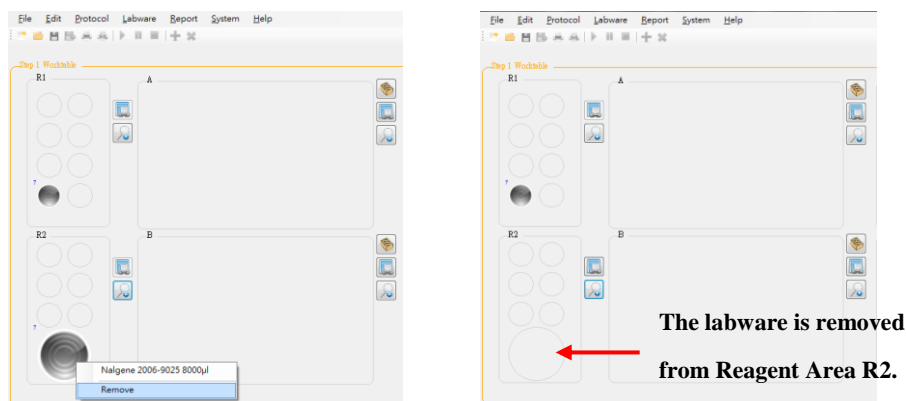

Note:

The labware selection can be removed only when all the selected wells of all commands are removed.

6.3 Editing the Protocol

After selecting the labwares, users can set up a sequence of commands as the protocol in “Step 2 Protocol” section (Section 2). Each command includes a command tab which includes the command number (#) and command function, a Source button to select the source wells of reagent/sample, a Destination button to select the destination wells of reagent/sample and an Option button to select the parameters of function.

6.3.1 Adding a command

Follow these steps to add a command to the procedure.

1. Left-click on any command Tab of the protocol.
2. Right-click on the command Tab and select **Add** from the context menu or select **Add** from the Edit Menu.

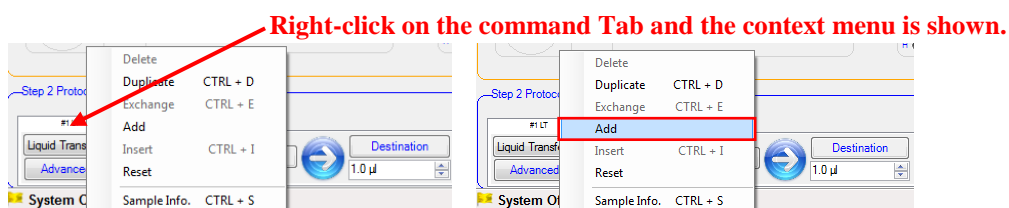

3. **The new command # LT is added next to the original command.** From the drop-down menu users can change the function of the new command # LT into any other function. The new function is added into the protocol.

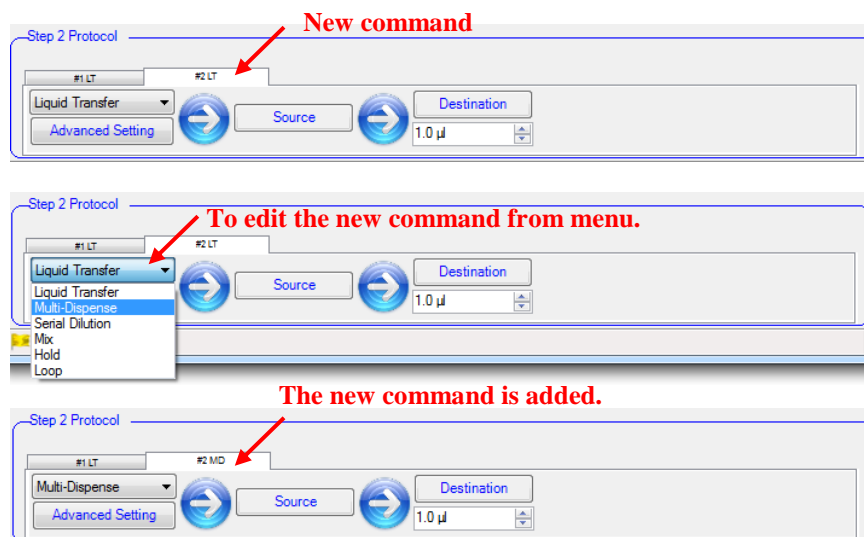

4. Complete the protocol by adding other commands in the same way.

6.3.2 Removing commands from the procedure

To remove one or several commands from a protocol, please follow these steps:.

1. Left-click on any command Tab that needs to be removed.
2. Right-click on the command Tab and select **Delete** from the context menu or select **Delete** from the Edit Menu.

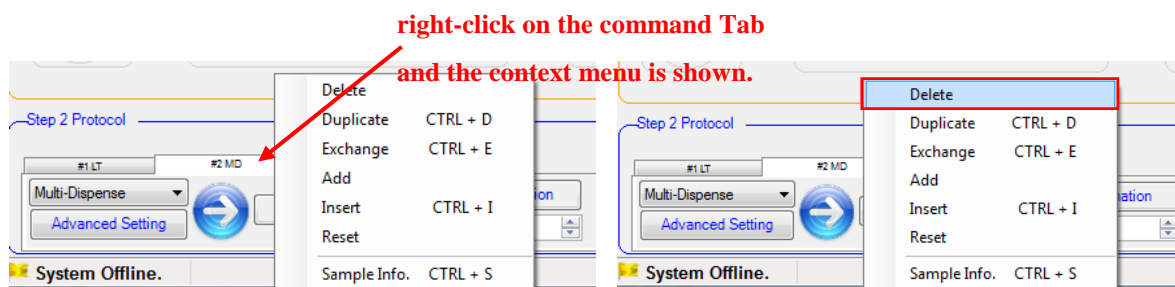

3. A warning message will appear. To delete this command, click “Yes”. The command will then be removed from the protocol.

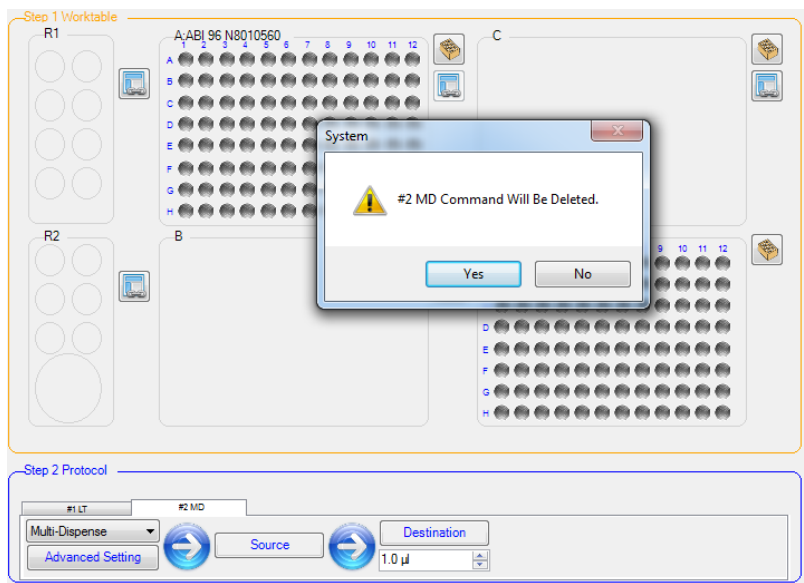

The command#2 is deleted.

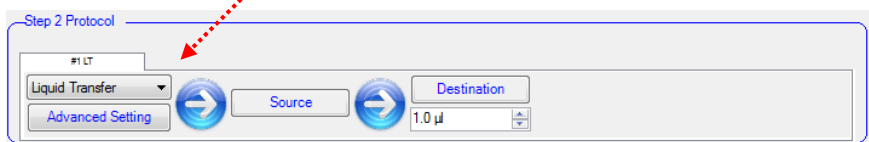

6.3.3 Duplicating a command

To duplicate a command, including its parameters and options, please follow these steps.

1. Left-click on the command Tab that needs to be duplicated.
2. Right-click on the command Tab and select **Duplicate** (Ctrl + D) from the context menu or select **Duplicate** from the Edit Menu.

right-click on the command Tab
and the context menu is shown.

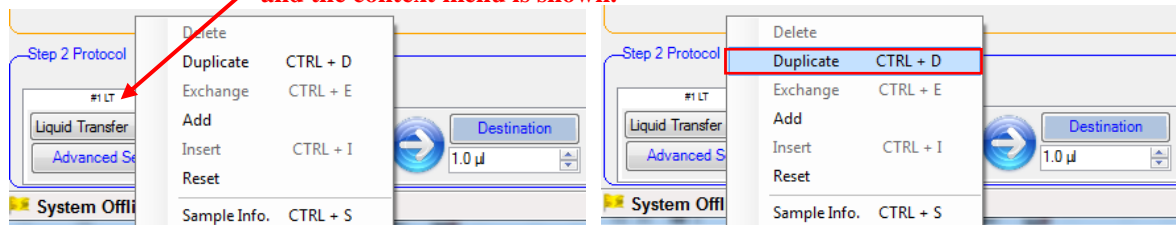

3. The command is duplicated and **the duplicate is next to the original command**. Users can edit the parameters of the original command and the duplicate independently.

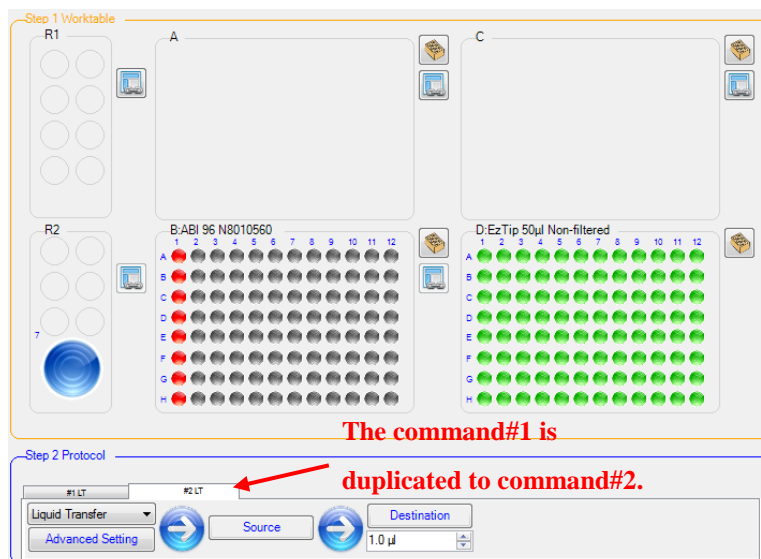

6.3.4 Inserting a command

To insert a command into the procedure at any position, please follow these steps.

1. Left-click on the command Tab to insert a new command before it.
2. Right-click on the command Tab and select ***Insert*** (Ctrl + I) from the context menu or select ***Insert*** from the Edit Menu.

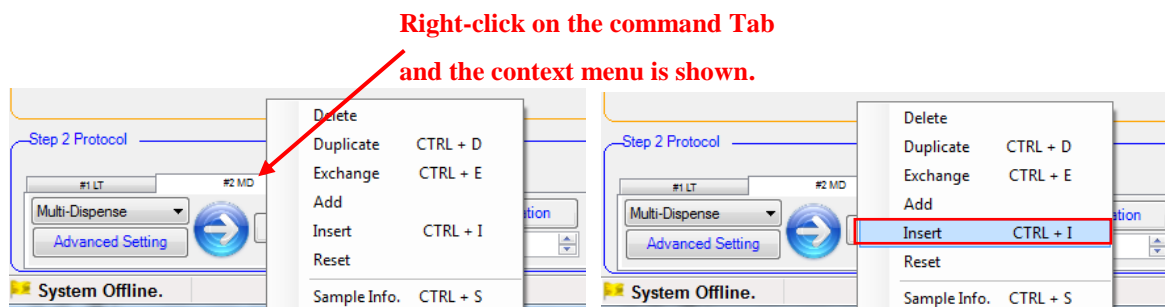
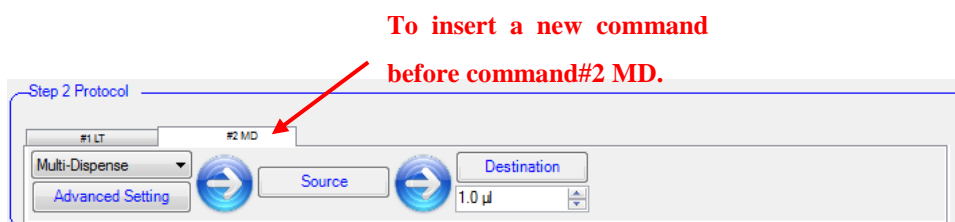

3. A new command # LT is inserted **before the original command**. Users can change the command # LT to other command functions from the drop-down menu.



6.3.5 Exchanging a command

To exchange a command, please follow these steps.

1. Left-click on one of the command Tab to exchange.

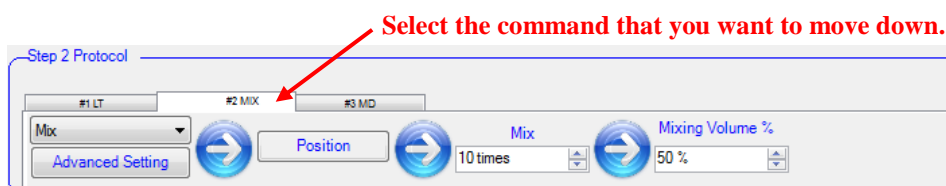

2. Right-click the command Tab and select **Exchange** (Ctrl + E) from the context menu or select **Exchange** from the Edit Menu.

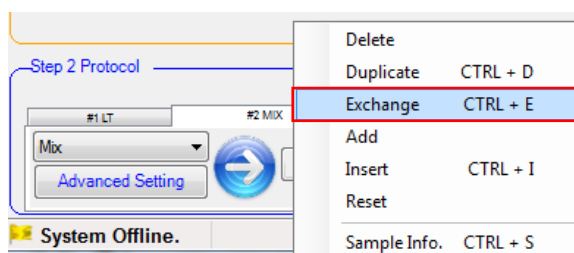

3. The command will move one command behind.

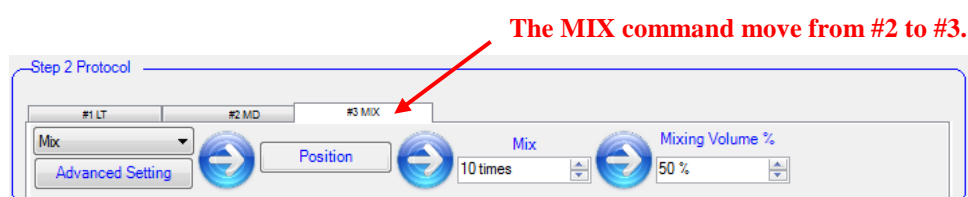

6.3.6 Resetting source and destination of a command

To clear the source and destination setting of a command, please follow these steps.

1. Left-click the command Tab to remove the source and destination setting.

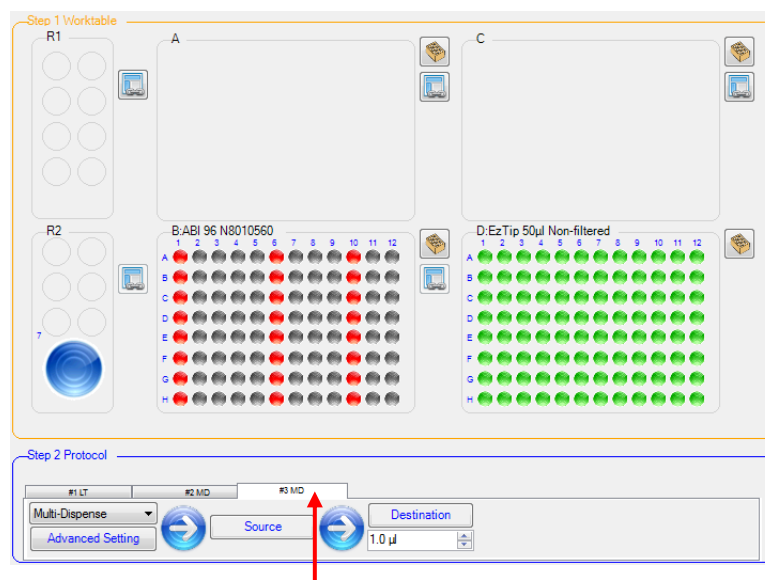

Select the command that you wish to reset the setting.

2. Left-click the command Tab and Select **Reset** from the context menu or select **Reset** from the Edit Menu.

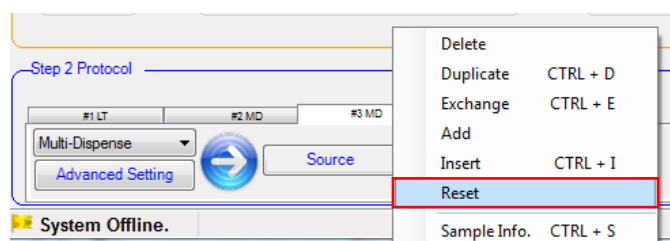

EzMate™ 401/601 Automated Pipetting System

3. A warning message appears. To reset, click “Yes”. The command will be reset.

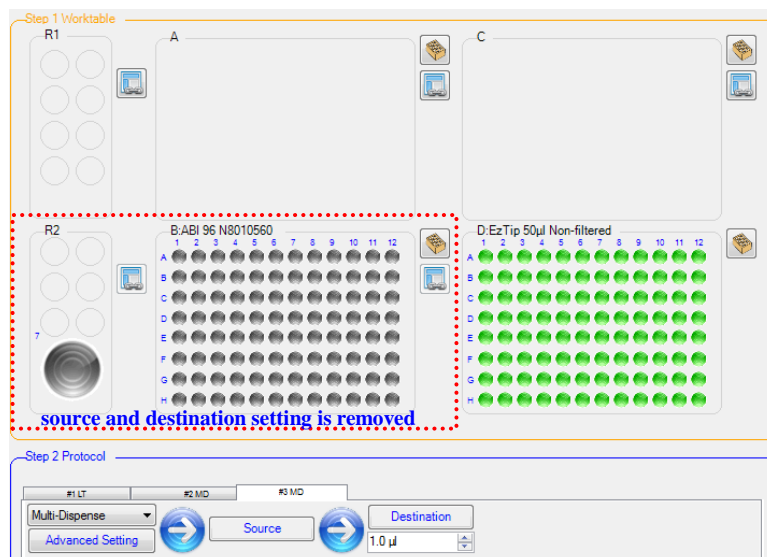
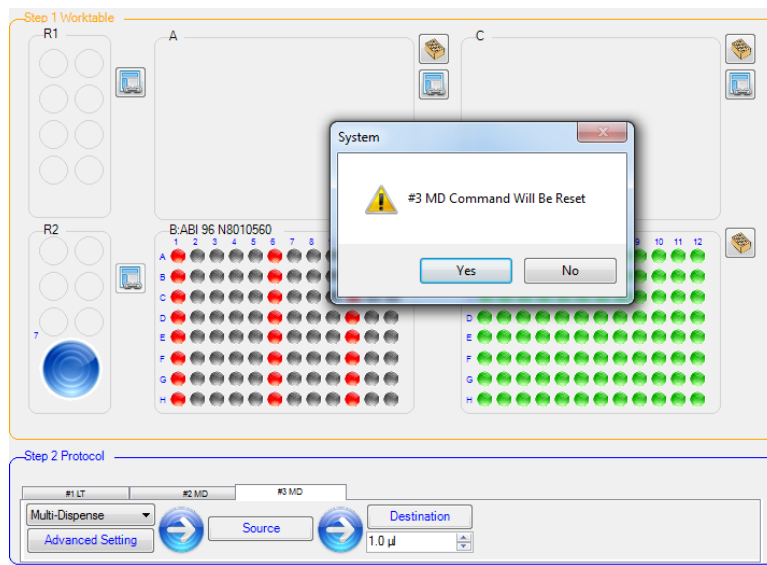

6.4 Command Overview

All available command functions are displayed in the drop-down menu in Step 2. Protocol section. There are six command functions, including Liquid Transfer (LT), Multi-Dispense (MD), Serial Dilution (SD), Mix, and Hold and Loop. Each command includes its individual settings, such as command function, source and destination positions, volumes and option, and so on. All commands are numbered in command tab, according to their processing order. The command tab also includes the abbreviation of command function. The default setting for a newly added command is Liquid Transfer (LT). The user can change the default command function from the drop-down menu.

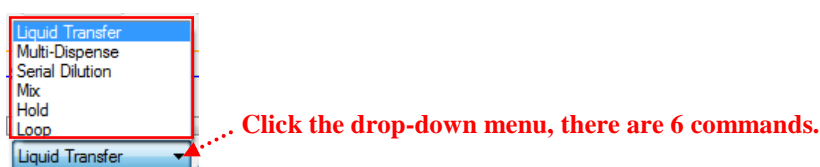

6.4.1 Liquid Transfer (LT)

Use **Liquid Transfer (LT)** command to **transfer liquids** (Reagents and Samples) **from several source positions to several destination positions (One to One)**, please follow these steps.

1. Select **Liquid Transfer** command from the drop-down menu.

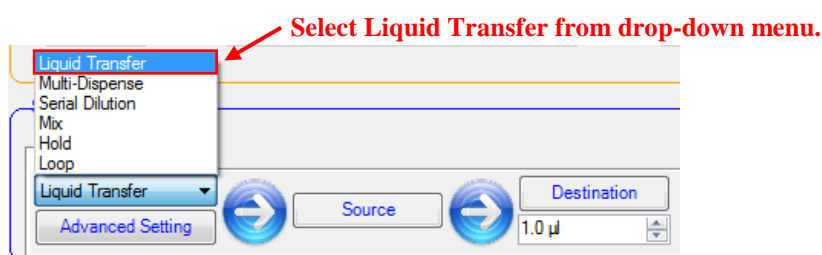

2. Selecting Source and Destination Positions.

The user must select the source and destination positions on the labwares for each command. **The labware must be placed on the worktable before operation.**

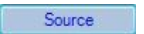
- Immediately upon adding a new command, users can select the source and destination positions by right-clicking the positions or framing an area.
- Press the  button, then click on/frame in one or several positions where the liquid will be extracted from the Worktable. The selected positions are highlighted in blue.

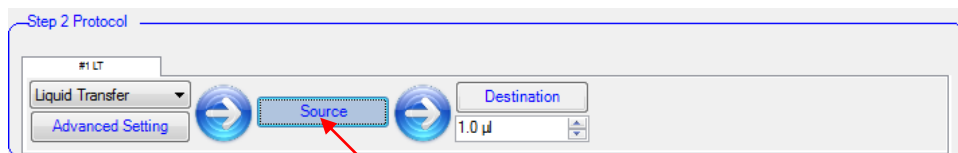

Press “Source” button to set source.

- Press the **Destination** button, then click on/frame in one or several positions where the liquid will be dispensed on the Worktable. The selected positions are highlighted in red.

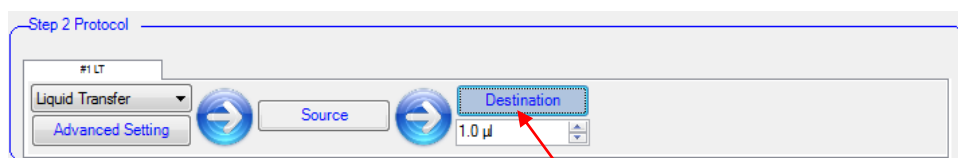

Press “Destination” button to set destination positions.

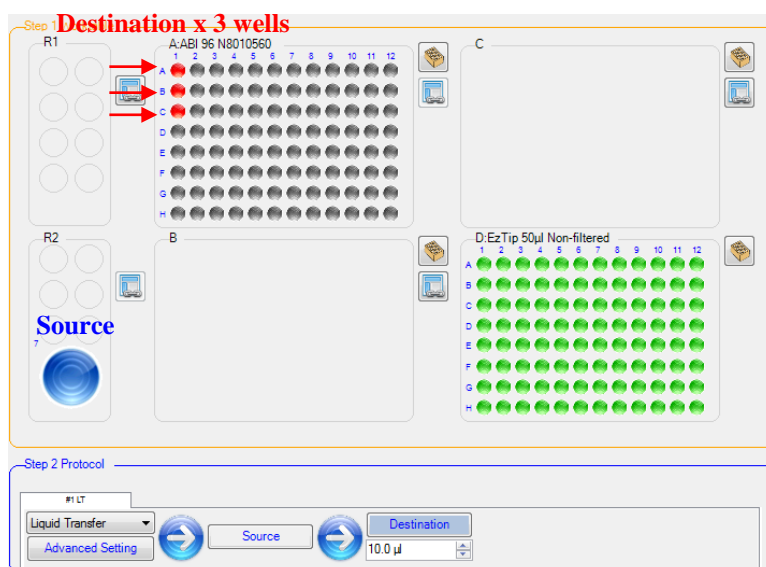

- **EzStarter** will record the selected pattern sequence and the EzMate 401/601 will transfer liquid from one source position to another destination position as the sequence defined by users.

3. Setting Dispense Volume

Key-in or press up and down key to set the volume to be dispensed. The volume setting ranges of different APM models are shown below.

	APM 50 μ l Model	APM 200 μ l Model
Volume Range	1 ~ 50 μ l	10 ~ 200 μ l
Volume Increment	0.5 μ l	1 μ l

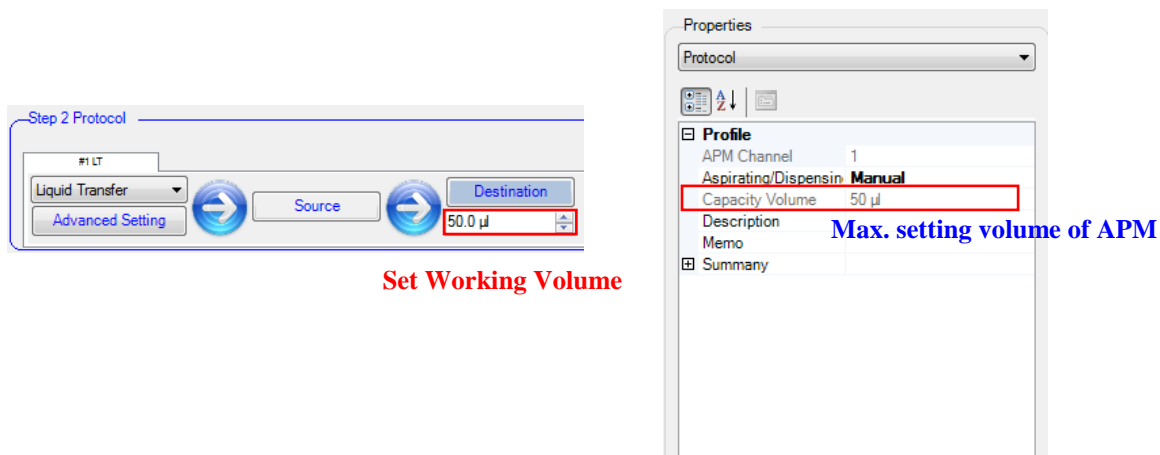

4. To specify further Advanced setting for the command, click on the Advanced Setting button to edit the location of Aspiration and Dispense, speed of Aspiration and Dispense, Mixing, Tips Change, Extra Aspiration (Reverse) and Blow-out.

6.4.2 Multi-Dispense (MD)

Use **Multi-Dispense (MD)** command to **transfer liquids** (Reagents and Samples) **from one or several source positions to another destination positions (One to Multiple or Multiple to Multiple)**.

After the settings are completed, the sum of the dispensing aliquots is aspirated into the tip. The APM aspirates from the first source position and dispense the setting volume to several destination positions sequentially. Next, the APM continues to aspirate from the second source position and dispense the setting volume to several destination positions sequentially. EzMate 401/601 will continuously operate in the same way to complete the command.

Note:

To increase the MD accuracy, MD default setting is designed to aspirate extra liquid volume (Reverse pipetting).

Multi-Dispense Default Setting	APM 50 µl Model	APM 200 µl Model
Reverse pipetting	<u>1</u> µl	<u>10</u> µl
Tip Change	Before Each Aspiration	Before Each Aspiration

1. Select **Multi-Dispense** command function from the drop-down menu.
2. Select the Source and Destination Positions

The user has to select the source and destination positions on the labwares for each command. **The labware must be placed on the worktable before operation.**

- Immediately after a command has been added to the procedure, select the source and destination positions by right-clicking the positions or framing an area.
- **One Source position to multi Destination positions**
 - Press the **Source** button, then click on/frame in one position where the liquid will be taken from the Worktable. The selected position is highlighted in blue.
 - Press the **Destination** button, then click on/frame in multi positions where the liquid will be dispensed on the Worktable. The selected positions are highlighted in red.

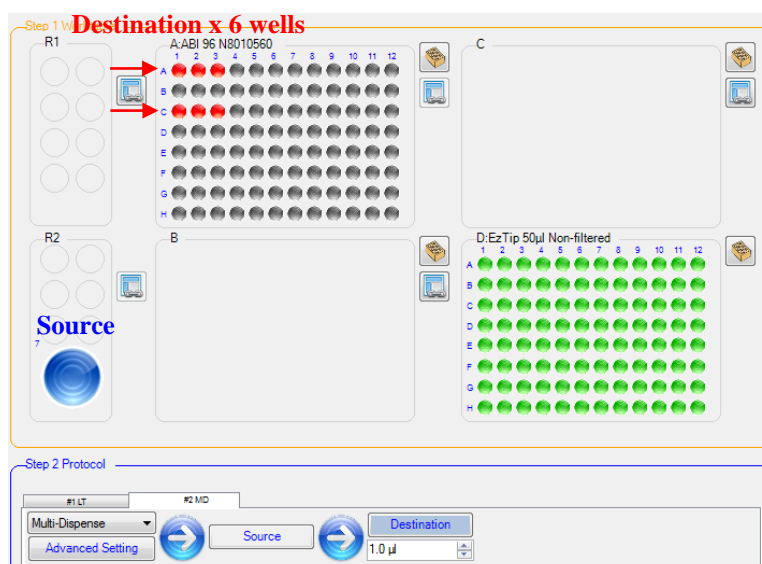

- **EzStarter** will record the selected pattern sequence and the EzMate 401/601 will transfer the liquid from one source position to multi destination positions as the sequence you defined.

- For example:
APM takes 7 μl liquid from 5 ml tube at R2 Area \rightarrow Dispense 1 μl to Area B, A1 well \rightarrow Dispense 1 μl to Area B, A2 well \rightarrow Dispense 1 μl to Area B, A3 well \rightarrow Dispense 1 μl to Area B, C1 well \rightarrow Dispense 1 μl to Area B, C2 well \rightarrow Dispense 1 μl to Area B, C3 well

● Multi Source positions to multi Destination positions

- Press the **Source** button, then click on/frame in multi positions where the liquid will be taken from the Worktable. The selected positions are highlighted in blue.

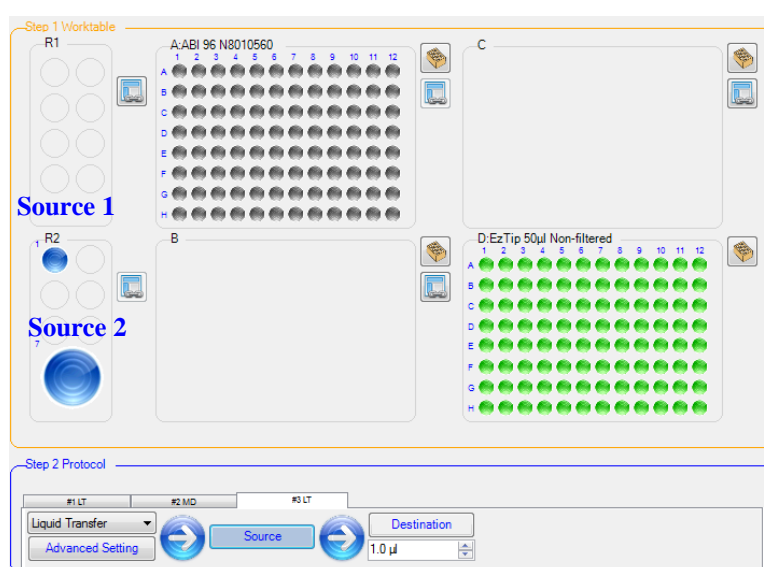

- Press the **Destination** button, then click on/frame in multi positions where liquid will be on the Worktable. The selected positions are highlighted in red.

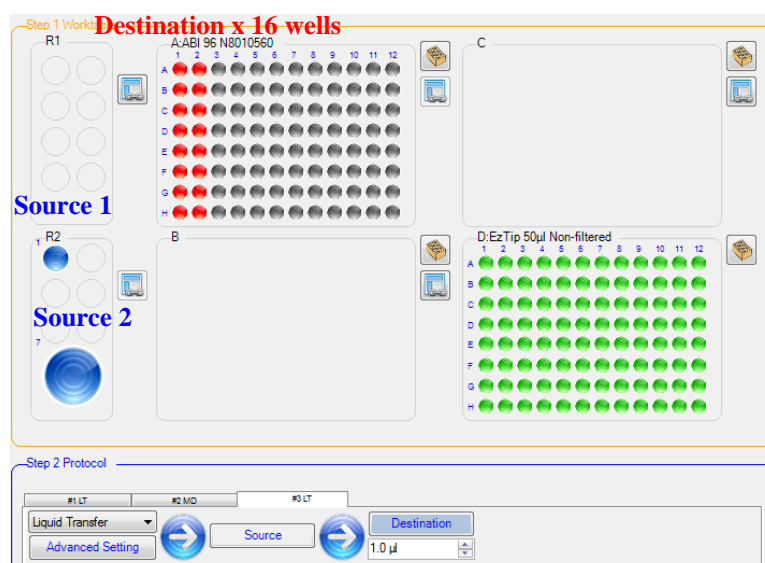

- *EzStarter* will record the selected pattern sequence and the EzMate 401/601 will transfer the liquid from multi source positions to multi destination positions as the sequence defined by users.
- For example:
APM takes 17 µl liquid from 2 ml tube at R2 Area → Dispense 1µl to Area A, A1 well → 1µl to B1 well → 1µl to C1 → 1µl to D1 → 1µl to E1 → 1µl to F1 → 1µl to G1 → 1µl to H1 → 1µl to A2 → 1µl to B2 → 1µl to C2 → 1µl to D2 → 1µl to E2 → 1µl to F2 → 1µl to G2 → 1µl to H2 → Change Tip → APM takes 17 µl liquid from 5 ml tube at R2 Area → Dispense 1ul to Area A, A1 well → 1µl to B1 → 1µl to C1 → 1µl to D1 → 1µl to E1 → 1µl to F1 → 1µl to G1 → 1µl to H1 → 1µl to A2 → 1µl to B2 → 1µl to C2 → 1µl to D2 → 1µl to E2 → 1µl to F2 → 1µl to G2 → 1µl to H2

3. Set the dispense volume

Key-in or press the up and down key to set the volume to be dispensed. The volume setting range is based on the APM model. **If the dispense volume of each well x number of Destination Wells is greater than the maximum APM volume, then the APM will perform additional pipetting cycle.**

For example:

APM Model: 50 µl

Dispense volume/each well: 20 µl

No. of Destination Wells: 3

The APM aspirates 40 µl (20 µl x 2 wells = 40 µl < the APM Max. volume: 50 µl) from the source position and dispenses the setting volume to the first two destination positions sequentially. Next, the APM continues to aspirate 20 µl from the source position and dispense to the third destination position.

- For example:
APM takes 41 µl liquid from 2 ml tube at R2 Area → Dispense 20 µl to Area A, A1 well → Dispense 20 µl to B1 well → Change Tip → APM takes 21 µl liquid from 2 ml tube at R2 Area → Dispense 20 µl to C1 well

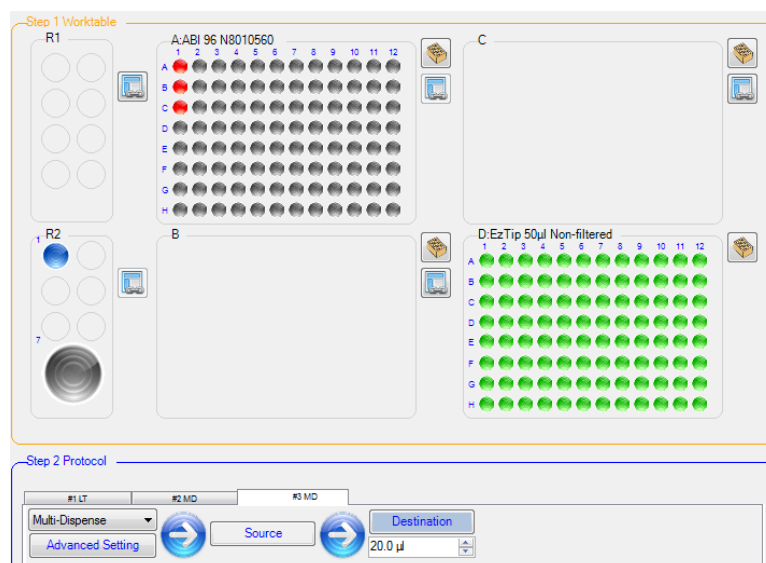

- To specify further Advanced Setting for the command, click on the [Advanced Setting](#) button to edit the location of Aspiration and Dispense, speed of Aspiration and Dispense, Mixing, Tips Change, Extra Aspiration (Reverse), Blow-out and Conditioning Volume.

6.4.3 Serial Dilution (SD)

The **Serial Dilution (SD)** command is a **modified Liquid Transfer command** to facilitate **the performance of the dilution series**. A defined volume is transferred **from one well to the next several times**.

- Select **Serial Dilution** command from the drop-down menu.
- Select Diluent, Sample and Reaction Positions

Users will need to select the diluent, sample and reaction positions on the labwares for each command. **The labware will need to be placed on the worktable before operation.**

- Immediately after a command has been added to the protocol, select the diluent, source and reaction positions freely by right-clicking on the positions or framing an area.
- Press the [Diluent](#) button, then click on/frame in one or multi positions where the liquid will be taken from the Worktable. The selected positions are highlighted in blue.

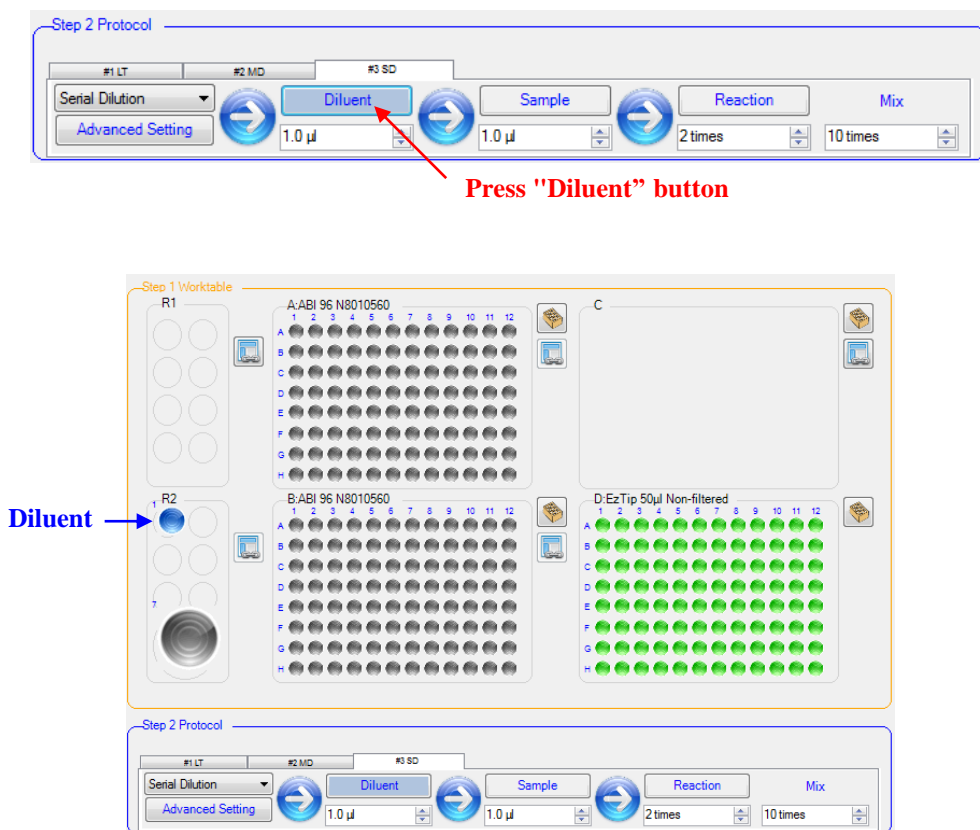

Press "Diluent" button

- Press the **Sample** button, then click on/frame in one or multi positions where the liquid will be taken on the Worktable. The selected positions are highlighted in red.

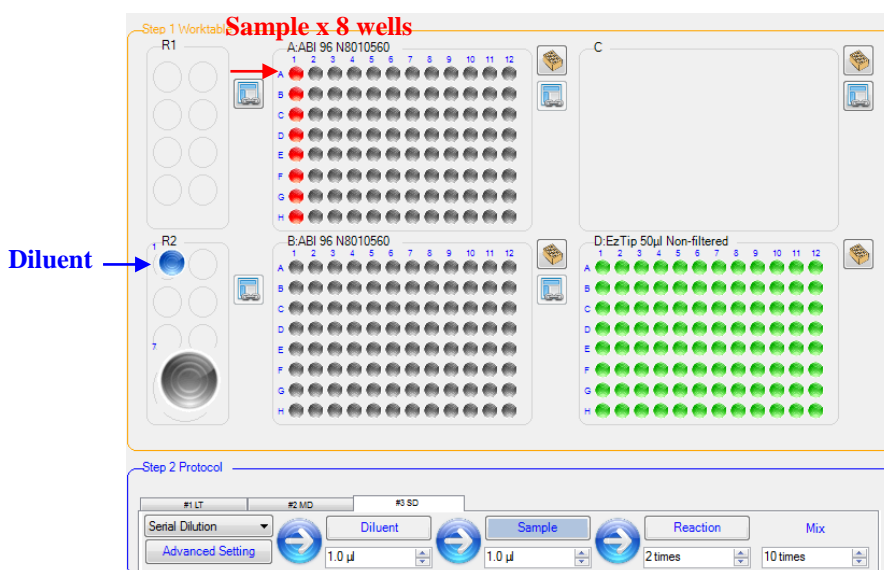

- Press the **Reaction** button, then click on/frame in one or multi positions where the liquid will be dispensed on the Worktable. The selected positions are highlighted in Orange and Yellow.

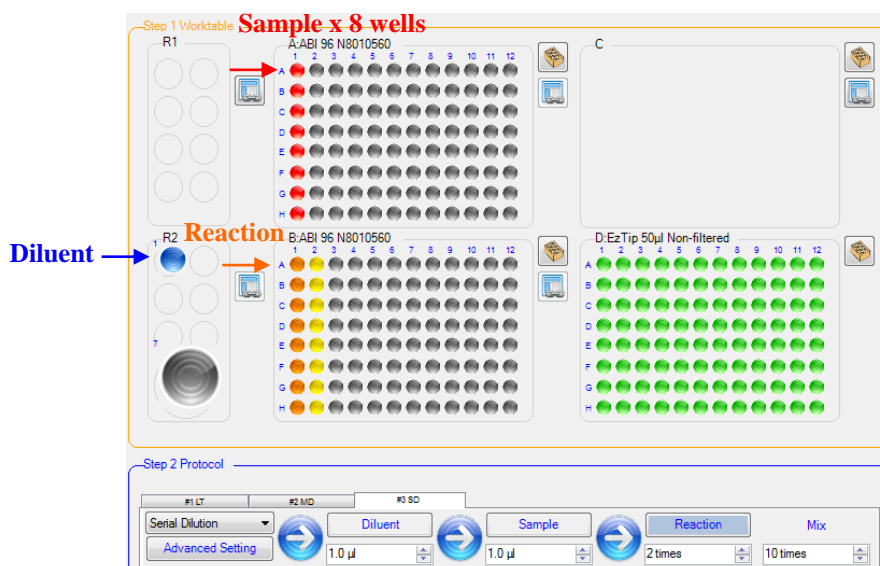

- **EzStarter** will record the selected pattern sequence and the EzMate 401/601 will transfer the liquid from one source position to one destination position as the sequence defined.

3. Set the volume

Key-in or press the up and down key to set the Diluent volume to be taken and the Sample volume to be taken. The volume setting range depends on the APM model.

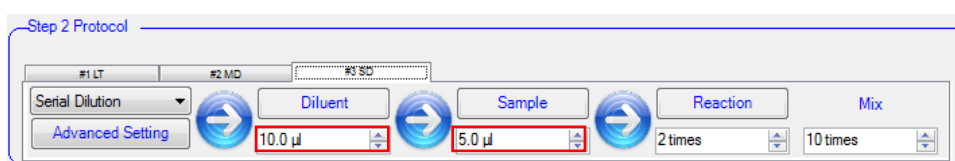

Set working volume

4. Set Reaction Cycles

The default Reaction Cycle is 2 times. Users can key-in or press the up and down key to set the cycle times. After you set the cycle times, press the **Reaction** button again or click on any buttons/dialogue boxes, the final reaction wells will be displayed.

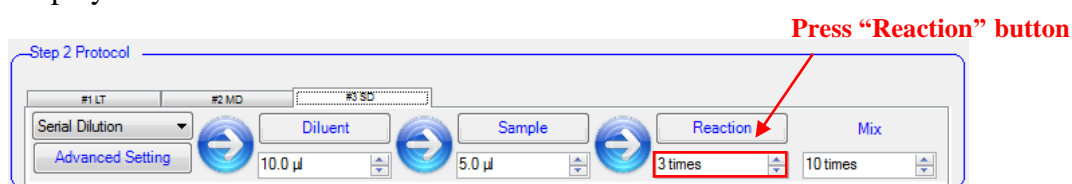

Set Working Cycles

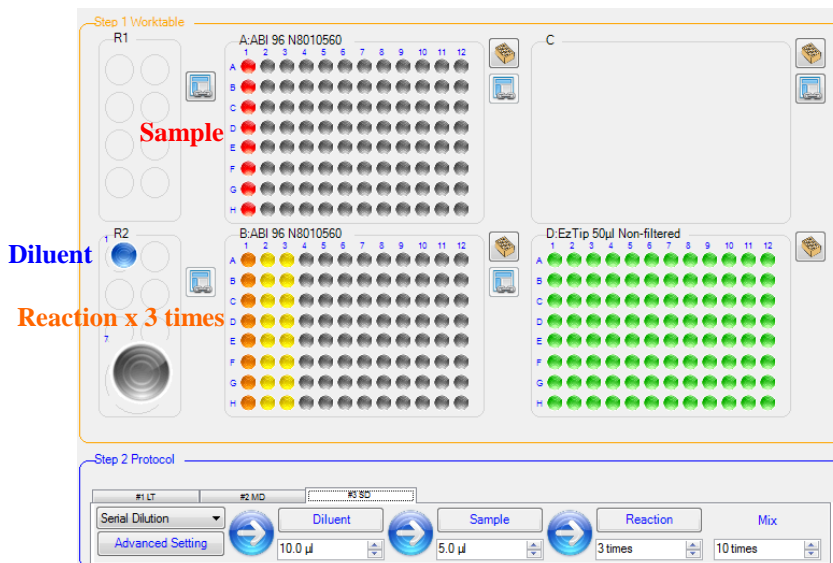

Note:

Advanced Setting- Dilution Direction: sets the direction of reaction positions

- Select “ **Horizontal (Default)** ”
 - The default dilution direction is **Horizontal**. If Horizontal is selected, the reaction wells will shift from left to right →.

For 96 well plate, the reaction cycle range is from 2 to 12 times.

For 384 well plate, the reaction cycle range is from 2 to 12 times.

- Select “ **Vertical** ”
 - Users can change the dilution direction to **Vertical**. If Vertical is selected, the reaction wells will shift from top to down↓.

For 96 well plate, the reaction cycle range is from 2 to 8 times.

For 384 well plate, the reaction cycle range is from 2 to 12 times.

5. Set the Mix Cycles

The default of Mix is 10 times. Users can key-in or press the up and down key to set the cycle times, which ranges from 1 to 100 times.

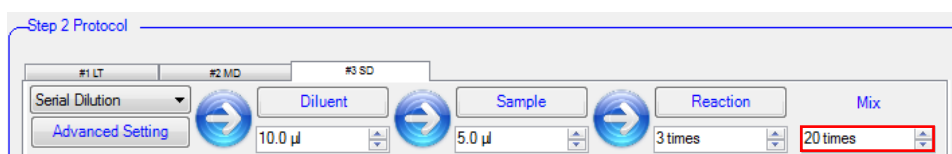

Set Mixing Cycles

6. To specify further Advanced setting for the command, click on the  button to edit the Mixing speed, Mixing Volume, Tips Change and Dilution Direction.

6.4.4 Mix

Use **Mix** command to **mix liquids within a position**. While the liquid is being mixed, it will aspirate into tip and dispense back into the same well.

1. Select the **Mix** command from the drop-down menu.

2. Select the Positions

Users have to select the mixing positions on the labwares for each command. **The labware must be placed on the worktable before operation.**

- Immediately after a command has been added to the procedure, users can define the mixing position freely by clicking on the mouse.
- Press the  button, then click on/frame in one or multi positions where the liquid will be mixed on the Worktable. The selected positions are highlighted in blue.



Press "Position" button

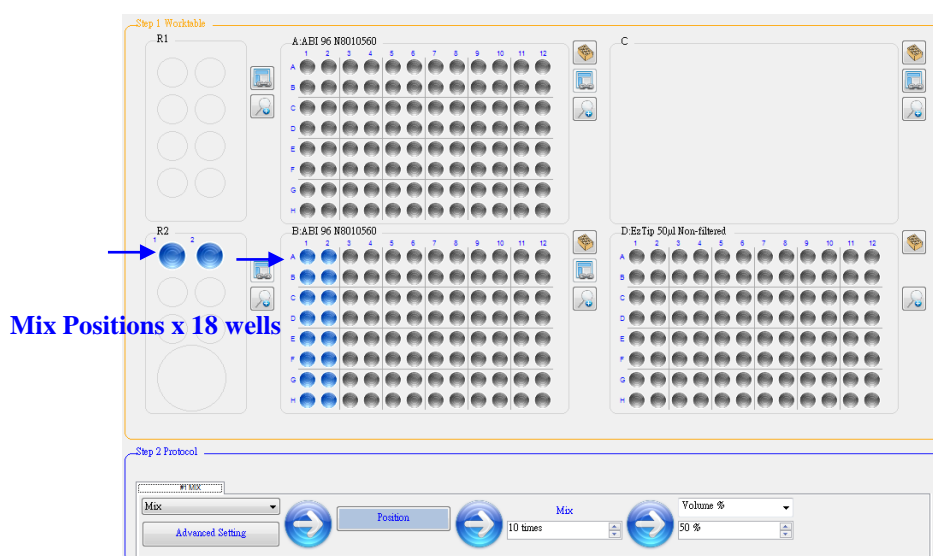

- *EzStarter* will record the select pattern sequence and the EzMate 401/601 will mix liquid as the sequence is defined.

3. Set the Mix Cycles

The default of Mix is 10 times. User can key-in or press the up and down key to set the cycle times, whose range varies from 1 to 100 times.

4. Set the Mixing Volume

Use the drop-down menu to select the **Volume %** or **Fixed Volume** for the mixing volume. Users can key-in or press the up and down key to set the Mixing Volume that is to be aspirated and dispensed during the mixing process. The default of mixing volume is 50% for **Volume %** mode and 1.0 µl for **Fixed Volume** mode. Users can set the range from 40 to 70% or volume up to the capacity of the tip used.

- Upon setting the Mixing Volume (%), *EzStarter* will automatically add the total dispensed liquid volume of the selected positions. Then, calculate the Mixing Volume that is to be aspirated and dispensed.

➤ Total dispensed liquid volume of a position x Mixing Volume (%) =
Mixing Volume

- The Mixing Volume should be \leq the APM maximum aspiration volume (APM50_{Max} is 50 µl, APM200_{Max} is 200 µl). **If the Mixing Volume is \geq the APM maximum aspiration volume, then the APM will aspirate and dispense the maximum volume.**

5. To specify further Advanced setting for the command, click on the  button to edit the location of Aspiration and Dispense, Mixing speed, Mixing Volume and Tips Change.

6.4.5 Hold

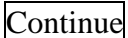
The **Hold** command specifies a **defined pause before the next command**. The APS will continue automatically after the hold time has lapsed or wait users to press the  button to continue to the next command.

1. Select **Hold** command from the drop-down menu.

2. Select Time

Users can key-in or press the up and down key to set Time that is the duration of pause. The maximum Hold time is 23 Hours 59 Minutes 59 Seconds.

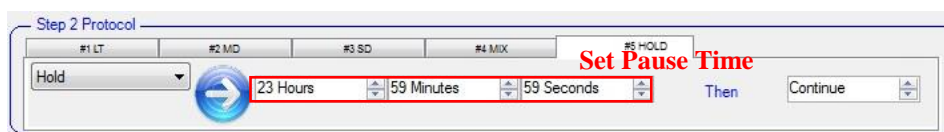

- When the protocol processes the Hold command, the timer will countdown. The status bar flashes and display the message “ Time Remain in xx:xx:xx ”.

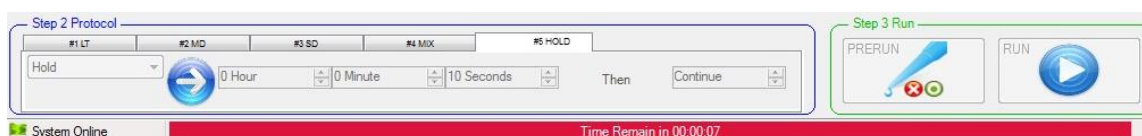

3. Select Continue or Wait

Immediately after the hold time is set, users can set how to process the next command. Press on the up and down key to set Continue or Wait.

- Select Continue: the protocol will continue automatically after the hold time has lapsed.
- Select Wait: wait for the user to press the Continue button to continue to the next command. The status bar flashes and displays the message “Press [Continue] Button to continue”.

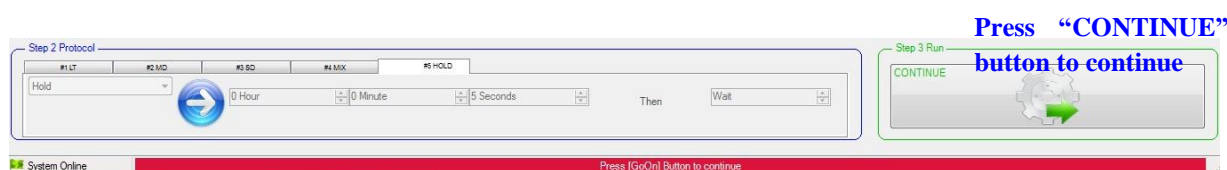

6.4.6 Loop

Use **Loop** function to **repeat several commands one or several times**. Loop allows users to select a few commands (from the Start Command to the End Command) and repeat them in selected times.

1. Select the **Loop** command from drop-down menu.

2. Select the Start command

Press the up and down key to set the Start Command which is next to the Loop command.



- Users must set the End command as the command before the Loop command.
 - For example: When the Loop command is in the sixth steps **#6 Loop**, the End command must be the fifth steps.

3. Select Repeat Cycles

The default Repeat Cycle is 1 time. Users can key-in or press the up and down key to set the cycle times, whose range varies from 1 to 11 times.



4. Submit Setting

- Immediately after the command setting is completed, press on the **Submit** button.

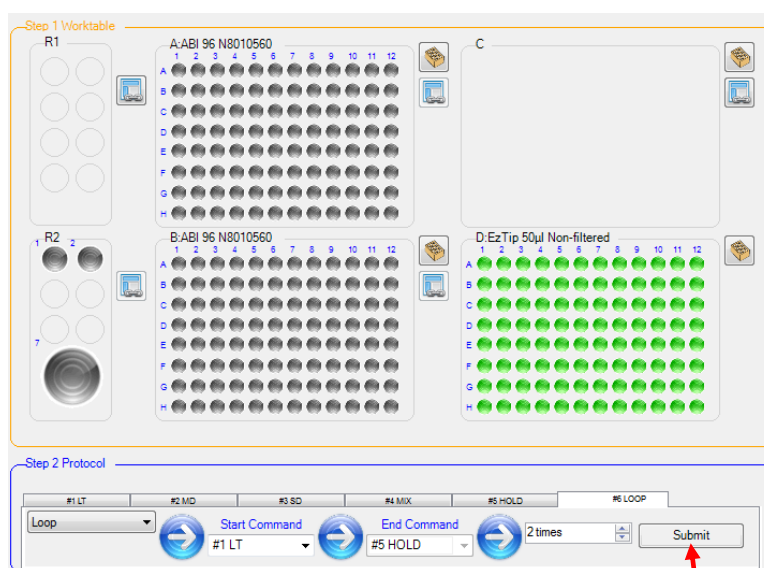

Press "Submit" button

- Click button and *EzStarter* will automatically calculate the feasibility of the loop. If the all settings are reasonable and feasible, a message window will show “Submitted”. On the contrast, it will show “Loop Submission Failure!”.
- After submitting the Loop setting, the Worktable will display the pattern that will be assigned to the protocol and the button will switch to button. The columns of Start Command and Repeat Cycles are locked for change.

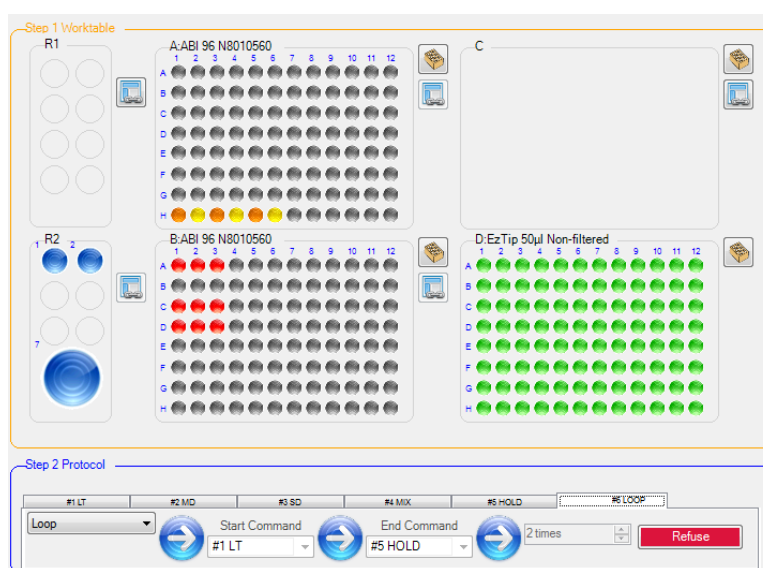

5. Edit or Remove Loop Command

- If users want to edit or delete the Loop command, press button. A message window “Refuse Will Reset All Loop Submitted” will display.
- If users click “Yes” to delete the Loop setting, the pattern of Worktable will be cleaned and the button will switch to button. The columns of Start Command and Repeat Cycles are open for input.

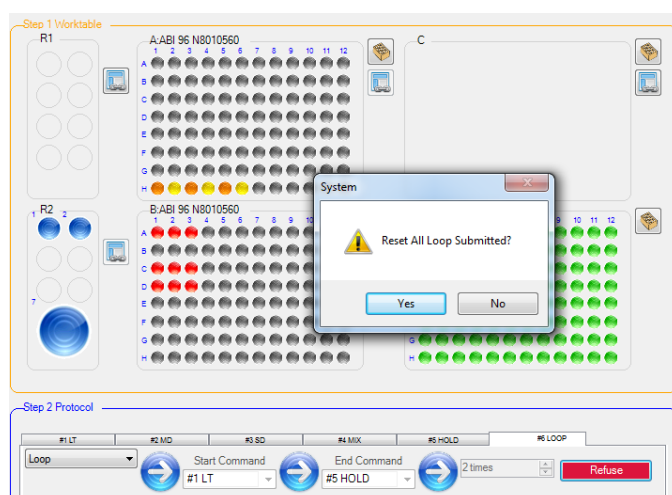

6.5 Commands' Advanced Settings

The following Advanced Settings are used for advance setting. Users can edit these parameters according to their requirements. Press the “Advanced Setting” button to enter the Advanced Setting setup. Press the “OK” button to save the Advanced Setting, or press the “Cancel” button to close the window without save the Advanced Setting.

6.5.1 Liquid Transfer's (LT) Advanced Setting

- Aspiration Location: the location where liquid is to be aspirated.
 - Select “ **Under Liquid Level (Default)**” or from “ **Bottom** ” .
 - **Under Liquid Level (Default)**: We have divided the vessel and plate into several height segments which are used for the virtual liquid level by calculation. For example: 2.0 ml tube is divided into 20 height segments. The pipette tip is generally immersed 2 to 3 mm into the liquid level before aspiration. The pipette tip will move downward gradually, because the liquid volume will decrease during aspiration.
 - **Bottom**: the tip is positioned approximately 2 mm above the bottom of the vessel or the plate. The distance from the bottom of the vessel or the plate depends on the vessel's or plate's type. For detailed Labware information please refer to *Appendix B: Recommended Labwares*.
 - **Top**: the tip is positioned on the top of the vessel or the plate.

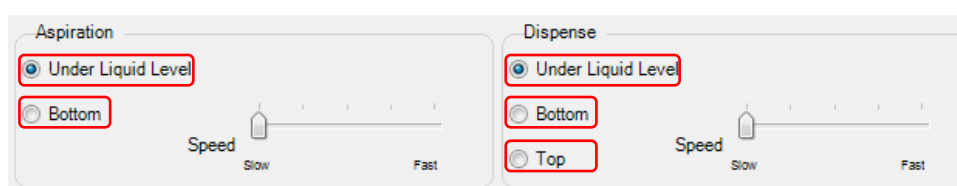

- Aspiration and Dispense Speed: sets aspiration and dispense speed.
 - **Five speeds are available, from slow to fast.** The default speed is slow.

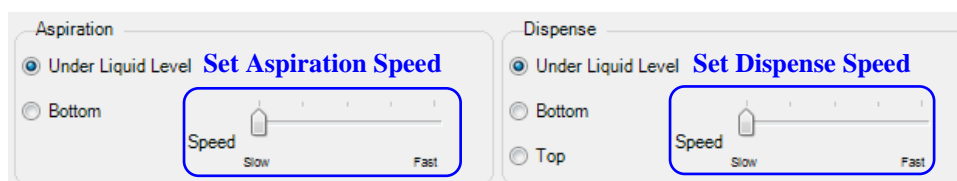

- APM aspiration and dispense speed table (The aspiration and dispense speeds are the same.).

	APM 50µl (µl/sec)	APM 200µl (µl/sec)
Speed 1 (Slow)	24	83
Speed 2	29	103
Speed 3(Middle)	37	133
Speed 4	51	190
Speed 5 (Fast)	83	333

● Mix

- The default setting is “No”. Select “Yes” if the liquid needs to be mixed. 3 conditions: “After Dispense (Default)”, “Before Aspiration” and “Both Dispense & Aspiration” can be selected from the drop-down menu.

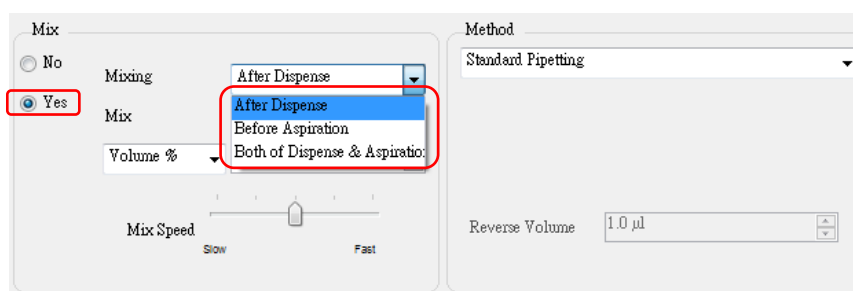

- Set Mix Cycles: from 1 to 100 times. The default is 10 times.
- Set Mixing Volume: from 40 to 70% or up to the capacity of the tip used. The default is 50%.
- Set Mix Speed: **five-speeds from slow to fast**. The default speed is slow.

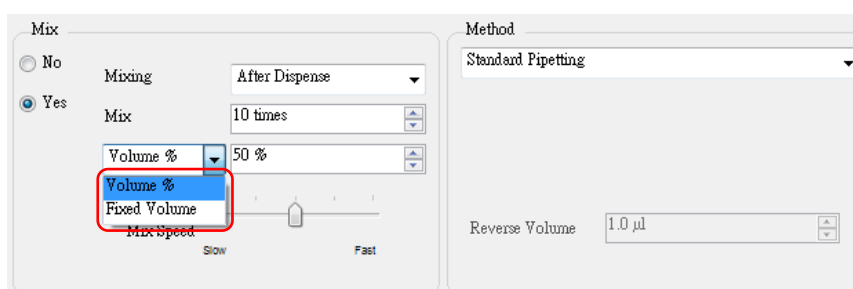

● Tip Change: set when to change tip

- Select “Yes” to specify when the tips are to be changed. 3 conditions: “Before Each Aspiration (Default)”, “When A Command Finishes” and “After xx Aspirations” are available.

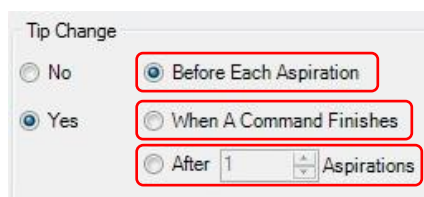

- Select “No”: Not to change tips. This option will affect the accuracy of the pipetting.

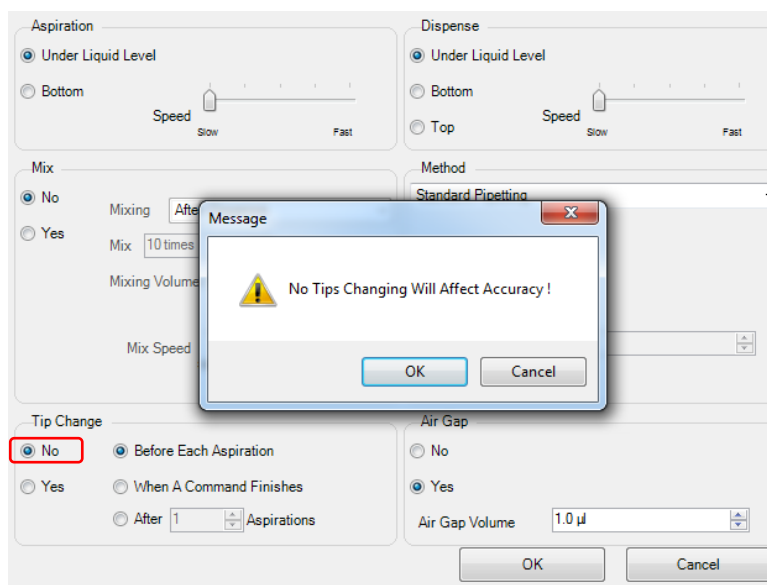

● Method:

- Use the Method drop-down menu to specify the pipetting method. The default setting is **Standard Pipetting**. You can select “ **Reverse pipetting** “ or “ **Blow-out** “.

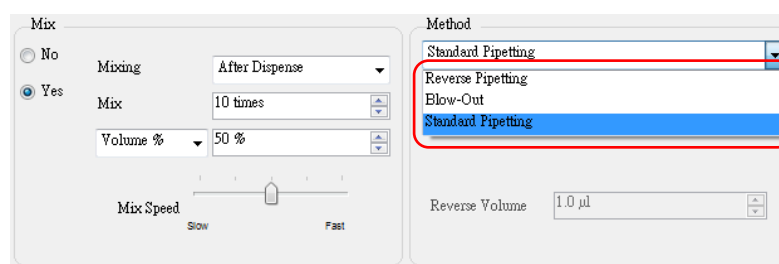

- **Reverse pipetting (Extra Aspiration):** If the Reversed pipetting function is selected, you can set how much extra liquid will be aspirated. The default reverse volume of APM50 Module is 1.0 µl, while APM200 Module is 10 µl.

The maximum reverse volume is 10% of the APM’s maximum aspiration volume.

Reverse Pipetting Volume of APM50 is 1.0 to 5.0 μl , while APM200 is 10 to 20 μl .

Method
Reverse Pipetting

Reverse Volume 5.0 μl

Note:

If the reverse pipetting function is selected, the Tip Change options will not be available.

Mix
 No
 Yes
Mixing Before Aspiration
Mix 10 times
Mixing Volume % 50 %
Mix Speed Slow Fast

Method
Reverse Pipetting

Reverse Volume 5.0 μl

Tip Change
 No
 Before Each Aspiration
 Yes
 When A Command Finishes
 After 1 Aspirations

Air Gap
 No
 Yes
Air Gap Volume 1.0 μl

OK Cancel

Tip Change options are not available

- **Blow-out (Post-Air):** If the blow-out function is selected, users can set how much air will be blown after each dispense. The default post-air volume of APM50 Module is 1.0 μl , while APM200 Module is 10 μl .

The maximum post-air volume is 10% of the APM maximum aspiration volume.

Post-Air Volume of APM50 is 1.0 to 5.0 μl , while APM200 is 10 to 20 μl .

Method
Blow-Out

Post-Air Volume 1.0 μl

Note:
If the blow-out function is selected, the Mix option will not be available.

6.5.2 Multi-Dispense’s (MD) Advanced Setting

This Multi-Dispense (MD) Option is the same as the **Liquid Transfer (LT)** command Option, so please refer to 6.5.1 Liquid Transfer (LT) Option section.

6.5.3 Serial Dilution’s (SD) Advanced Setting

- Dilution Direction: sets the direction of reaction positions.

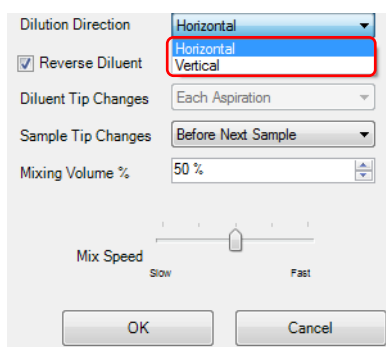

- Select “ **Horizontal (Default)**”
 - The default dilution direction is **Horizontal**. If Horizontal is selected, the reaction wells will shift from left to right →.

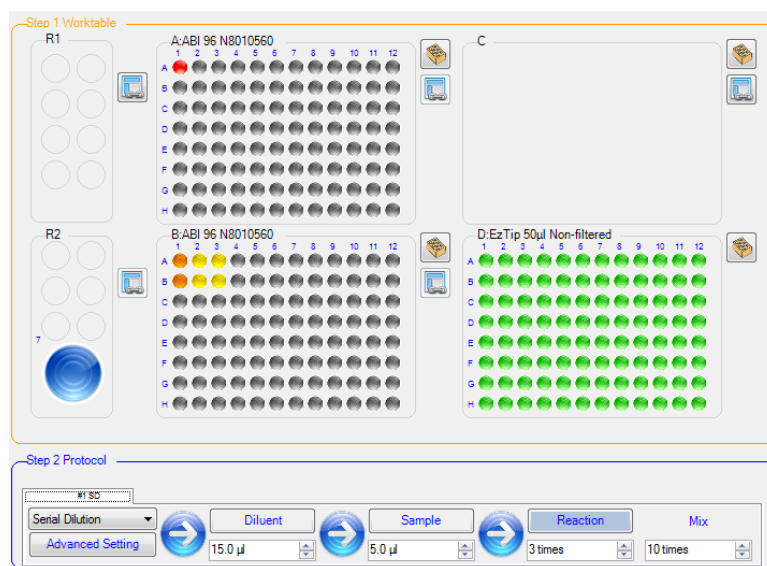

For 96 well plate, the reaction cycle range is from 2 to 12 times.

For 384 well plate, the reaction cycle range is from 2 to 12 times.

➤ Select “ **Vertical** ”

-Users can change the dilution direction to **Vertical**. If Vertical is selected, the reaction wells will shift from top to down↓.

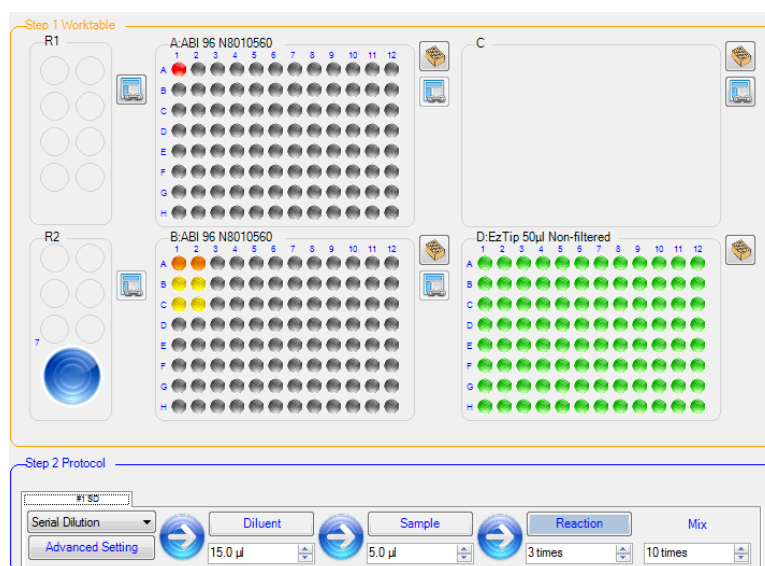

For 96 well plate, the reaction cycle range is from 2 to 8 times.

For 384 well plate, the reaction cycle range is from 2 to 12 times.

● Tip Change: sets when to change tip

- For Buffer/Diluent: select change tip “**Before Aspirate Sample (Default)**” or “**Each Aspiration** ”.

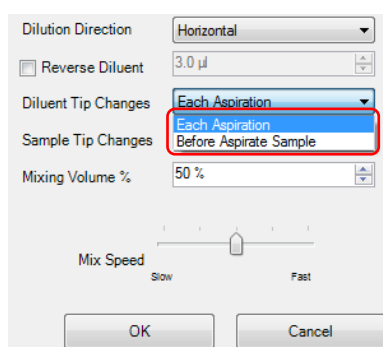

-The default Tip Changes for Buffer/Diluent is **Before Aspirate Sample**. If option is selected, APM will use the same tip to aspirate and dispense Buffer/Diluent. It can save the usage of tip, but the accuracy may decrease.

-Users can select **Each Aspiration**; APM will use new tips before each aspiration. If the buffer is viscous, we suggest to change the tip before each aspiration to increase the accuracy and precision.

- For example: select Tip Changes> “**Before Next Sample (Default)**” or “**Each Dispense**”.

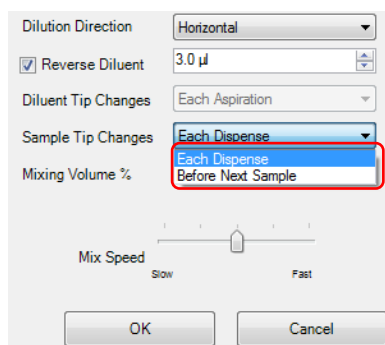

-The default tip change for Sample is **Before Next Sample**. If users select the option, APM takes sample #1 → dispense sample #1 to reaction well #1 → Mix → take the diluted sample from reaction well #1 and dispense to reaction well #2 → Mix → change tip before APM takes sample #2

-If users select “**Each Dispense**”, APM will use new tip after each dispense.

- **Mixing Volume (%)**: Set the Mixing Volume (%) that is to be aspirated and dispensed during the mixing process.
 - The default of Mixing Volume (%) is 50%. Users can set the range from 40 to 70%.

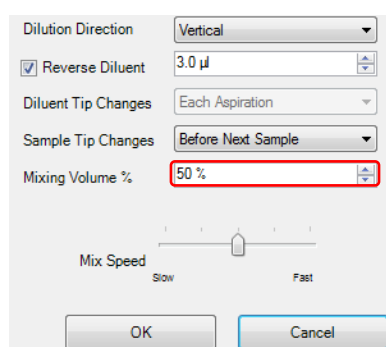

- Mix Speed
 - **Five-speeds are available from slow to fast.** The default speed is medium. If the liquid foams up, we suggest set the mixing speed to the slowest.

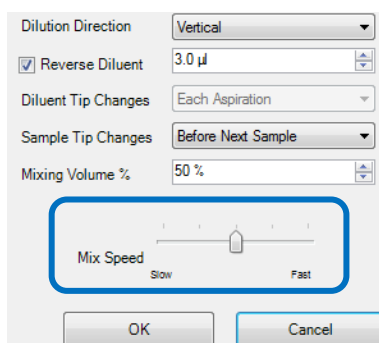

6.5.4 Mix's Advanced Setting

- Tip Change: sets when to change tip
 - Select “**Tip Change**” option to specify when the tips are to be changed. 3 conditions: “**After Each Mix (Default)**”, “**When A Command Finishes**” or “**Not**” are available.

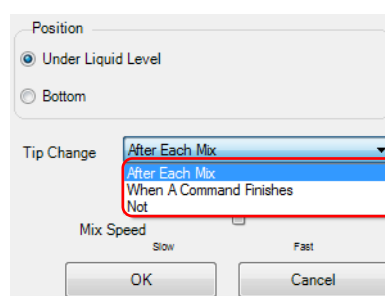

- Mix Speed
 - **Five-speeds are available from slow to fast.** The default speed is medium. If liquid foams up, we suggest to set the mixing speed to slowest.

6.6 Run and Pre-run

After selecting the labwares and setting the protocol, users can proceed to Step 3. Run (Section 3). In this section, there are two options: Run and Pre-run. Press the PRERUN button to check the protocol before operation. Press the RUN button to execute a protocol.

6.6.1 Pre-run a protocol.

Before running the protocol, simulate the whole process. Press  button, then select the options in Prerun Method.

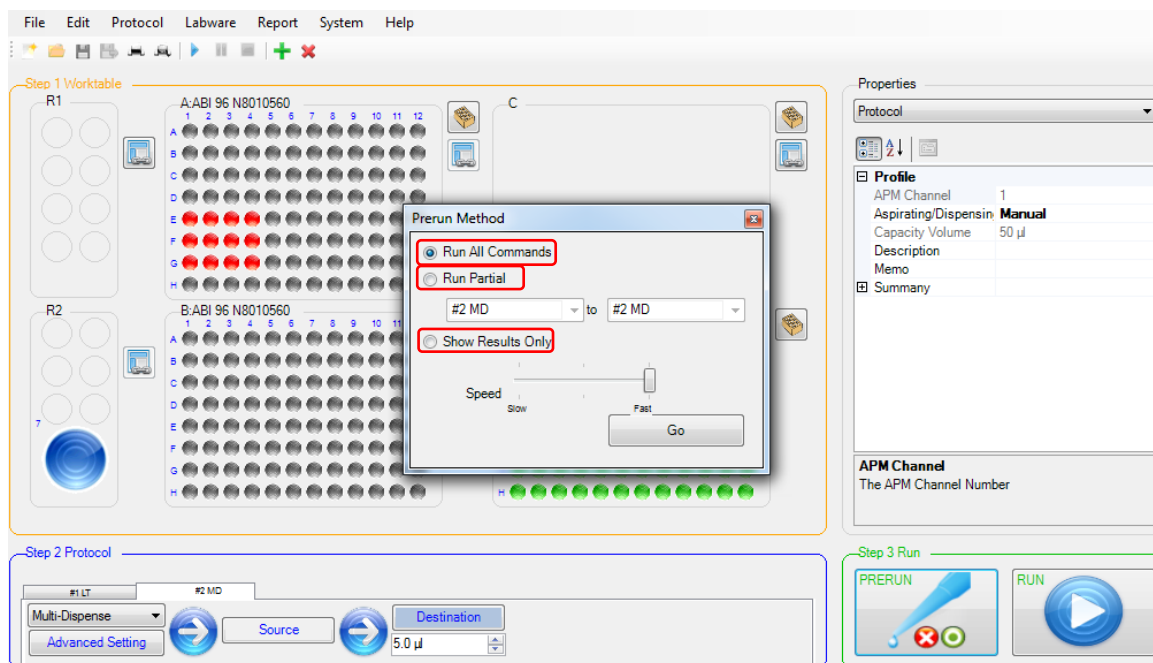

- **Run All Command:** to carry out the simulation step by step.
- **Run Partial:** to carry out the selected specific commands that from drop-down menu.
- **Show Result Only:** the worktable displays results after executing all commands.
- **Speed:** varies the simulation speed by moving the speed bar.

6.6.2 Run a protocol

After setting all commands of the protocol, press  button in the bottom of the main (in Step 3 Run section) to start a run.

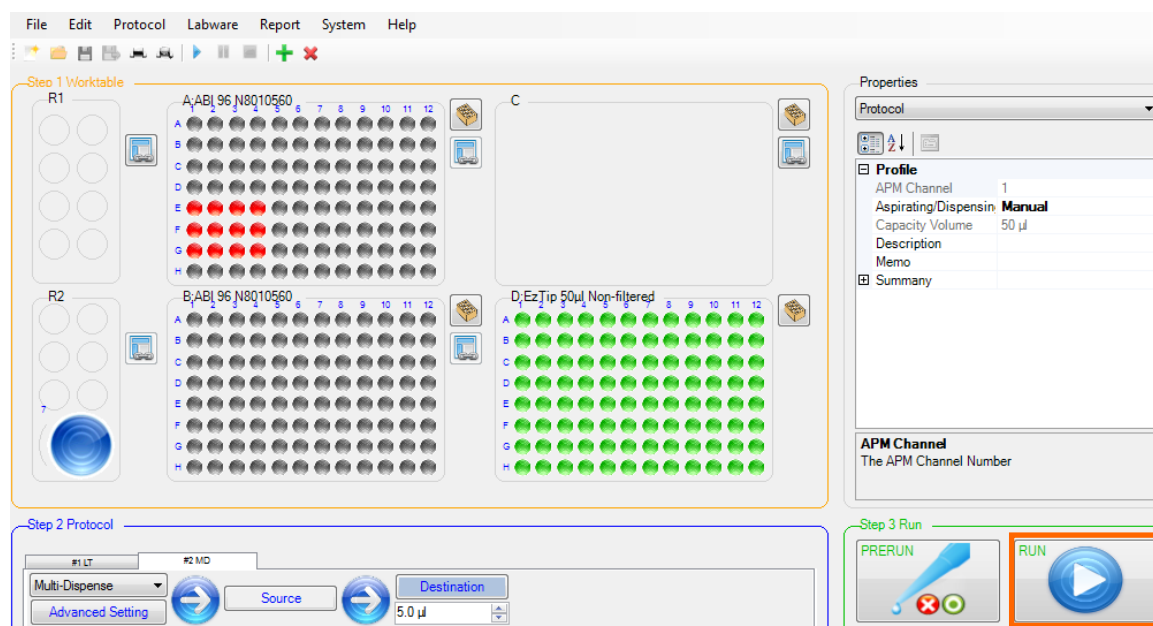

Save the protocol before starting a run,.

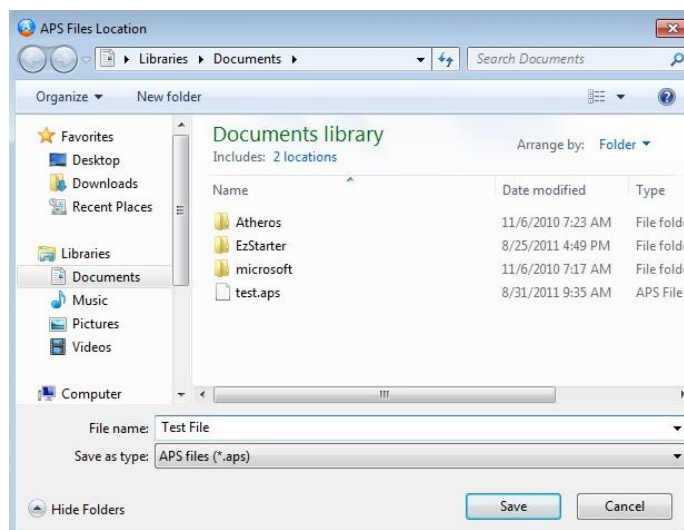
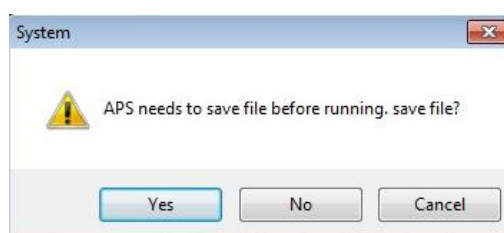

A checklist window will appear after the protocol is saved. Please ensure the following:

- Correct tubes, plate and tips types have been selected.
- All tubes, plates and tips are in their correct locations.
- The required tips are selected.

- Enough buffer, diluent, reagents, samples have been provided. (All required volumes of Source wells will be shown in Detail.)

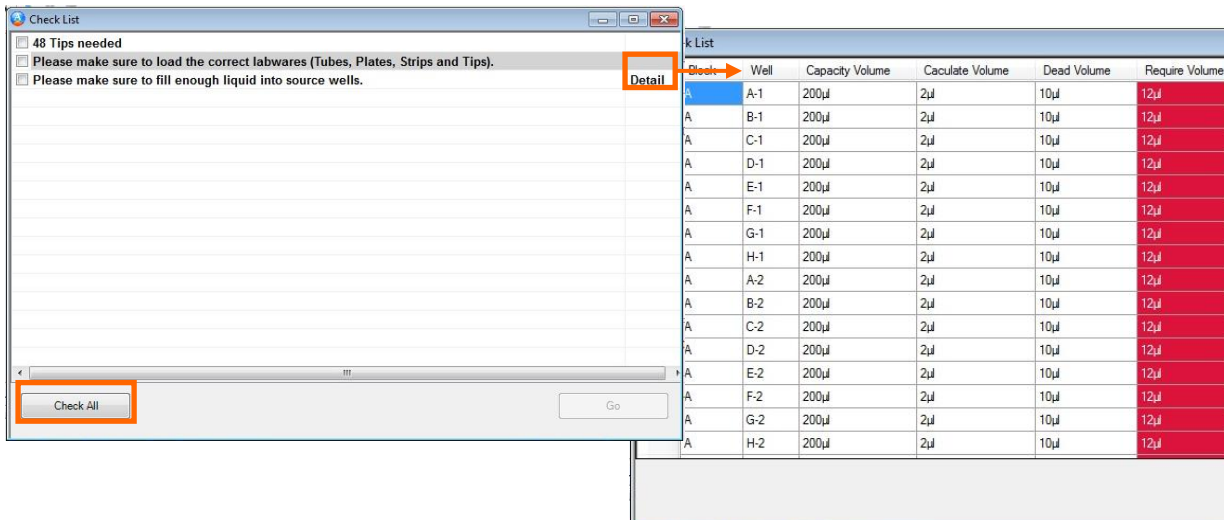

Press **Check All** and **Go** button, and the run will proceed.

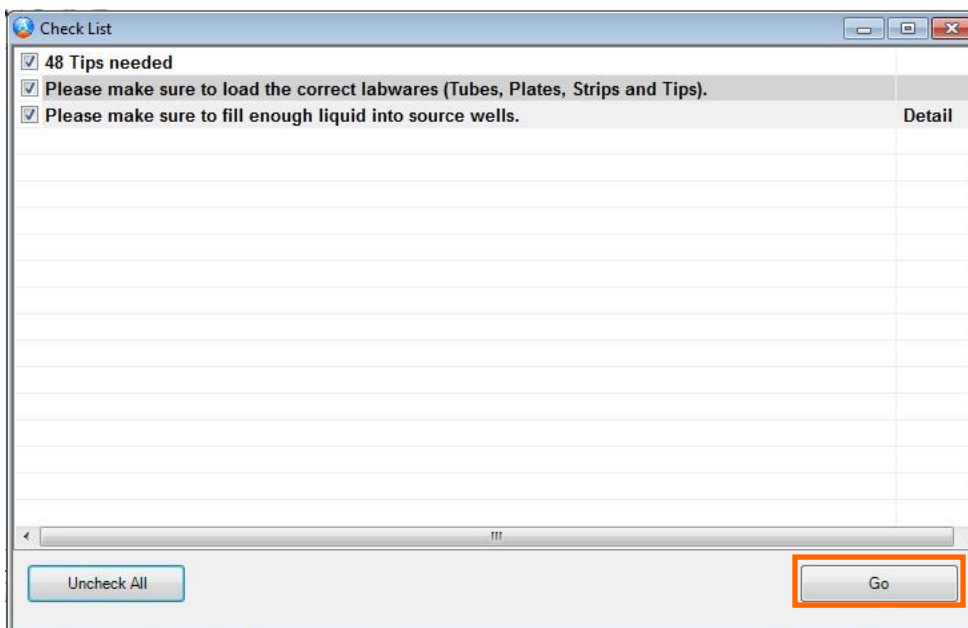

7. Maintenance

EzMate 401/601 is a robust, reliable instrument that requires minimal maintenance. Its enclosure protects it from dust and foreign objects, thus its motion control components, such as linear guide, belt and motor, require almost no maintenance.

The rest of the components, such as APM, Adapters, worktable can be cleaned, disinfected or serviced as described in the sections below.

Caution!

UV radiation will damage the exposed cables, APM and motion control parts.

7.1 Cleaning the Worktable

Use a soft, lint-free cloth and mild detergents, such as 5% bleach, or 70% ethanol to clean the worktable.

7.2 Cleaning the Automated Pipetting Module (APM)

The housing of APM module is made of ABS plastic material. To clean the APM, remove the APM from the Z-axis platform first. Use a soft, lint-free cloth and mild detergents, such as 5% bleach, or 70% ethanol to clean the APM.

Caution!

APM can't be autoclaved.

7.3 Servicing the Automated Pipetting Module (APM)

To maintain the Accuracy and Precision, such as the hand-held manual or electronic pipettes, return the APM to Arise or its service partners for annual calibration service. The fuse is located in the power socket module, just below the power connector. Replace the fuse if the unit does not turn on when the power switch is turned on.

7.4 Cleaning the Adapters

Use a soft, lint-free cloth and mild detergents, such as 5% bleach, or 70% ethanol to clean the surface of Adapters. The Adapters, except the CoolBlocks, can be autoclaved for 20 minutes at 121 °C and 1 bar pressure.

7.5 Replacing a Fuse

The fuse is located in the power socket module, just below the power connector. If the unit does not turn on when the power switch is turned on, then replace the fuse.

To replace the fuse:

1. Disconnect the power cord from the unit.
2. Remove the fuse drawer with a small-blade screwdriver.
3. Pull the fuse out of the fuse socket and replace the fuse with the correct current rating: 3.5A, 5 x 20mm, Glass Tube.
4. Reinsert the fuse into the fuse socket and the fuse drawer.

8. Troubleshooting

Problem	Cause	Action
Power failure.	Blown fuse.	Replace a new fuse.
Droplets left inside the tip.	Unsuitable tip.	Use Beckman Biomek® 3000 compatible tips.
Leakage or volume too small.	Worn-out internal O-ring.	Replace the defect internal O-ring with a new one.
Failure to aspirate.	The lower manifold is not correctly attached.	Detach and reassemble
	Foreign material blocking the hole at bottom of the cone.	Use MIX mode and distilled water to wash.
	Piston movement is blocked.	Lubricate piston.

8.1 Error Messages

Code	Message	Cause	Remedy
1001	Not an existing file!!	Original protocol file has been deleted or moved.	Check file location.
0001	System Initial Error	Initial APS system failure	Is system storage space enough?
1002	Not a APS protocol format file	File damaged.	Check protocol file format.
0002	Protocol has wrong APM selection!!	Protocol has the wrong selection with connected APM module.	Change APM module or recreate a new protocol for current APM module.
2001	Connection time out error!!	No connection /w APS when protocol is running.	Check USB/RS-232 connection cable.
0003	APM NOT AVAILABLE!!	Wrong APM module during software calibration.	Check APM's serial number.
0004	APS NOT AVAILABLE!!	No connection /w APS when system is initialized.	Check USB/RS-232 connection cable or reset APS.
2002	Loop Submission Failure!!	Microplate layout cannot do loop function	Check microplate layout.
9901	Printing Error!! Check Printer.	PC has no connection /w printer.	Check printer connection.

Appendix A : Recommended Consumables

The consumables in the list below are tested and recommended for EzMate 401/601 by Arise Biotech. Other consumables can be used on EzMate 401/601 as well, as long as distributors have defined their Calibration file before usage.

Description	Vendor	Catalog Number	Capacity Volume(µl)	Dead Volume(µl)	Type
96-well Plates					
FrameStar 96, Red Frame, Natural wells	4titude	4ti-0730/R	200	10	Half-Skirted
FrameStar 96, Blue Frame, Clear Wells	4titude	4ti-0960/B	100	10	Full-Skirted
FrameStar 480,96 well Semi skirted,Clear Frame	4titude	4ti-0951	100	10	Half-Skirted
FrameStar 96, Clear Frame, Natural wells	4titude	4ti-0900/C	200	10	Half-Skirted
0.2 ml 96 well plate	ABgene	AB1100	200	10	Half-Skirted
96 Well MicroAmp® PCR Plate	ABI	N8010560	200	10	Half-Skirted
96 Well MicroAmp® Fast PCR Plate	ABI	4346907	100	10	Half-Skirted
96 Well Half Area, Flat Bottom, Non-Treated (ELISA)	Costar	3695	100		Full-Skirted
96 Well, Flat Bottom (ELISA)	Costar	9017	200		Full-Skirted
LightCycler® 480 Multiwell Plates 96, Half-skirt	Roche	047729692001	100	10	Half-Skirted
96 Well PCR Plate, Half-skirt	Sarstedt	72.1979.202	300	10	Half-Skirted
96-Well PCR Plates	Labcon	3977-520	200	10	Non-Skirted
96-Well PCR Plates	Labcon	3972-520	200	10	Half-Skirted
0.2 ml 96 well plate	Protech	SP-0446	200	10	Half-Skirted
1.2 mL Deep Well	Sarstedt	82.1970.002	1200	30	Deep-Well

Appendix A : Recommended Consumables

Plate (Round)					
0.2ml 96 Well Plate	SSI	3450-00	200	10	Half-Skirted
384-well Plates					
FrameStar 384, Purple Frame, Clear wells	4titude	4ti-0384	20		Full-Skirted
384 Well MicroAmp [®] PCR Plate	ABI	4309849	30		Full-Skirted
LightCycler [®] 480 Multiwell Plates 384	Roche	047729749001	20		Full-Skirted
384 Well PCR Plate	Labcon	3983-520	25		Full-Skirted
8-strip PCR Tubes					
0.2 ml 8 well strip	Biomate	PTN40-02	200	10	Non-Skirted
0.2 mL 8-Strip	ABI	4316567	200	10	Non-Skirted
0.2 mL 8-Strip	Labcon	3940-550	200	10	Non-Skirted
Micro Tubes					
Micro Tube 1.5 ml	Axygen	MCT-150-C	1500	20	
Micro Tube 2.0 ml	Axygen	MCT-200-C	2000	20	
Micro Tube 1.5 ml	Sarstedt	72.692.005	1500	20	
Micro Tube 1.5 ml	Sarstedt	72.690.001	1500	20	
Micro Tube 2.0 ml	Sarstedt	72.694.006	2000	20	
Micro Tube 1.5 ml	SSI	23400-00-R2	1500	20	
1.7 mL SuperClear Tubes	Labcon	3012-870	1700	20	
Safe-Lock Tube 1.5 ml	Eppendorf	0030 120.086	1500	20	
Bottle					
Narrow-Mouth Bottle PP, 8mL	Nalgene	2006-9025	5000	1200	
Tips					
50µl w/o filter, Non-Sterile	EzTip	T00-ezar00-00	50		Non-filtered
200µl w/o filter, Non-Sterile	EzTip	T00-ezar01-00	200		Non-filtered
50µl w/o filter, Sterile	EzTip	T00-ezar02-00	50		Non-filtered, Sterile
200µl w/o filter, Sterile	EzTip	T00-ezar03-00	200		Non-filtered, Sterile
50µl w/o filter,	Beckman	A21578	50		Non-filtered

EzMate™ 401/601 Automated Pipetting System

Non-Sterile					
200µl w/o filter, Non-Sterile	Beckman	717251	200		Non-filtered
50µl, Filtered, Sterile	Beckman	A21586	50		Filtered, Sterile
125µl, Filtered, Sterile	Beckman	717253	125		Filtered, Sterile
50µl w/o filter, Non-Sterile	Axygen*	FX-50-R	50		Non-filtered
200µl w/o filter, Non-Sterile	Axygen*	FX-250-R	200		Non-filtered
50µl, Filtered, Sterile	Axygen*	FXF-50-R-S	50		Filtered, Sterile
165µl, Filtered, Sterile	Axygen*	FXF-180-R-S	165		Filtered, Sterile

Notice!

* Since the inner diameters of Axygen Beckman compatible robotic tips are small than the original Beckman Biomek 3000 tips', the Axygen Beckman compatible robotic tips can't fit the 8-channel APMs well. Please ask Arise' authorized distributors for custom-made 8-channel APMs which fit Axygen Beckman compatible tips well.

Appendix B : Technical specifications

Worktable Capacity: Area A/B/C, 2 or 3 x 96 / 384 SBS PCR plates,
 Area C/D, 2 or 1 x 96 tip rack (50/200 µl),
 Reagent Area 1: 8 x 1.5/2 ml microcentrifuge tube,
 Reagent Area 2: 6 x 2 ml storage tube (free standing) and 1 x 5 ml bottle.

Dispensing Function: Liquid (Sample/Reagent) Transfer (LH)
 Multiple Dispense (MD)
 Serial Dilution (SD)
 Hold (Pause)
 Mixing (MIX)
 Loop

Automated Pipetting Module(APM): Interchangeable 1/8-channel, Maximum volume 50 µl/200 µl.

Connection: RS-232, USB2.0

Power Supply: 100~240V, 50/60 Hz, 100W

Size (W x D x H): 590 x 440 x 460 mm

Weight (N.W.): 25 Kg

Operating Temperature*: 15 to 30°C

Operating Humidity (R.H.) *: 40 ~ 85%

*Note: Operating Temperature and Operating Humidity are for the operation of EzMate 401/601. To achieve better accuracy and precision, the operating temperature (21 ~ 25°C ±0.5°C) and humidity (60~90%) based on ISO-8655 standards should be followed.

Performance of Automated Pipetting Module (APM)

1/8 channel- Volume 50 µl		
	1 µl	50 µl
Accuracy (Rel.)	± 7%	± 1%
Precision (Rel. CV)	≤ 7.5%	≤ 0.4%

EzMate™ 401/601 Automated Pipetting System

1/8 channel - Volume 200 μ l		
	10 μ l	200 μ l
Accuracy (Rel.)	$\pm 3\%$	$\pm 0.8\%$
Precision (Rel. CV)	$\leq 1\%$	$\leq 0.15\%$

Note: According to ISO-8655 standards (Gravimetric method), APM is calibrated in temperature (21 ~ 25°C \pm 0.5°C) and humidity (60~90%) controlled environment. Twice-distilled water, robotic tips and microbalance were used.

Appendix C : EzMate 401/601 Sample Protocols

EzMate 401/601 has four sample protocols for users' reference. Users can click Open protocol → User's document → EzStarter → Protocol Sample File to find the protocols (4 Series folder for EzMate 401, 6 Series folder for EzMate 601). Open the protocol whose file name (APM50-1 represents 1-channel, 50µl APM) indicates the same APM was mounted on the APS, and put the correct labwares on the adapters. Then, click RUN and the APS will run the sample protocol.

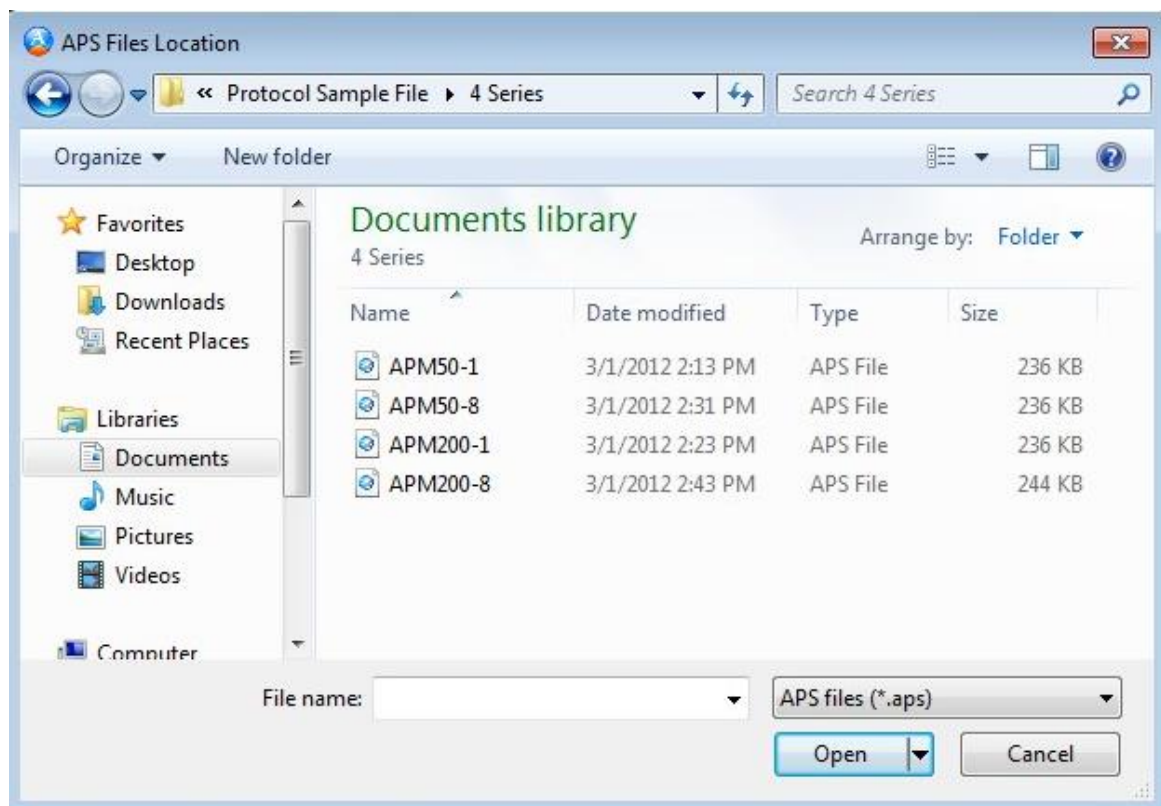

Appendix D : CE Declaration



Arise Biotech Corp.

3 F, No. 5, Alley 2, Sih-wei Lane, Jhong-jheng Rd,
Sin-dian District, New Taipei City,
Taiwan, R.O.C.

Declaration of Conformity

Product Name: EzMate™ 401 Automated Pipetting System

Model Names: EzMate™ 401

All models comply with the following European standards:

EMC: EN 61010-1, EN 61010-2-81

Safety: EN 55011/B, EN 61000-6-1, EN 61000-3-2/3, EN 61000-4-14,
EN 61326-2-6

To the best of my knowledge and belief, these units conform to these standards.

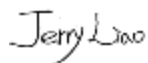

Name: Jerry Liao

Position: Quality Assurance Manager

Issue Date: 2011/5/30

Appendix E : EzStarter Installation and Uninstallation

For USB connection, except EzStarter, users are required to install the USB driver as well. The USB driver can be found in the Software DVD (directory: SiLabs\CP210xVCPInstaller.exe).

EzStarter Installation

To install the EzMate 401/601 Software-*EzStarter*, please insert the EzMate 401/601 Software DVD into the DVD Driver of the computer and start the installation process by running the setup.exe file. Please follow these steps set up EzStarter.

Step 1- Welcome to the EzStarter Setup Wizard

The installation wizard will guide users through the installation process. Selecting **Next>** will take users to the next screen.



Step 2- Select Installation Folder

This step allows users to select the folder into which they want the software to be installed. The **Browse** button enables users to locate specific folders. Selecting **Next>** will take users to the next screen.

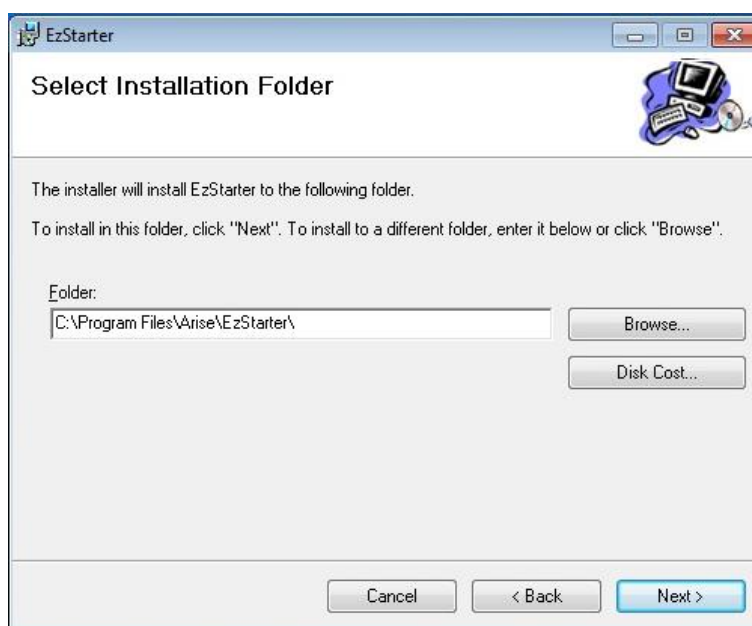

Step 3-Confirm installation

Select **Next >** to start the software installation procedure. Select **Cancel** to exit the setup.

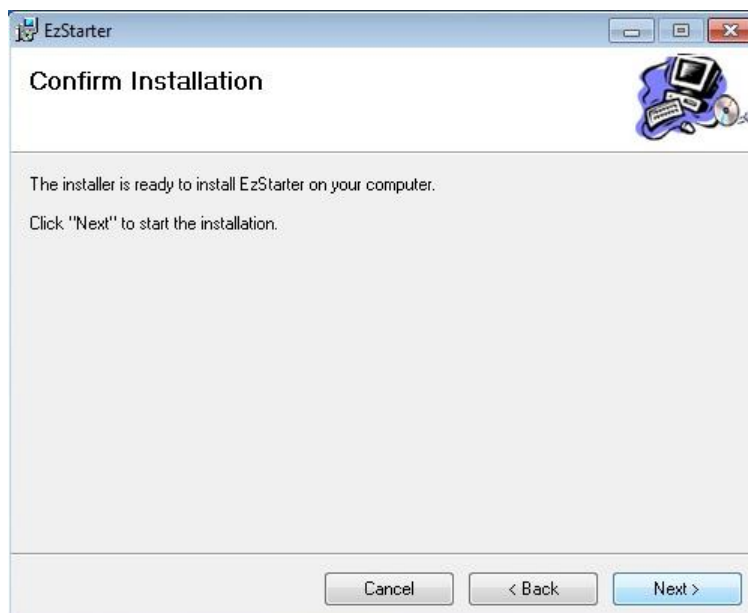

Step 4- Installing EzStarter

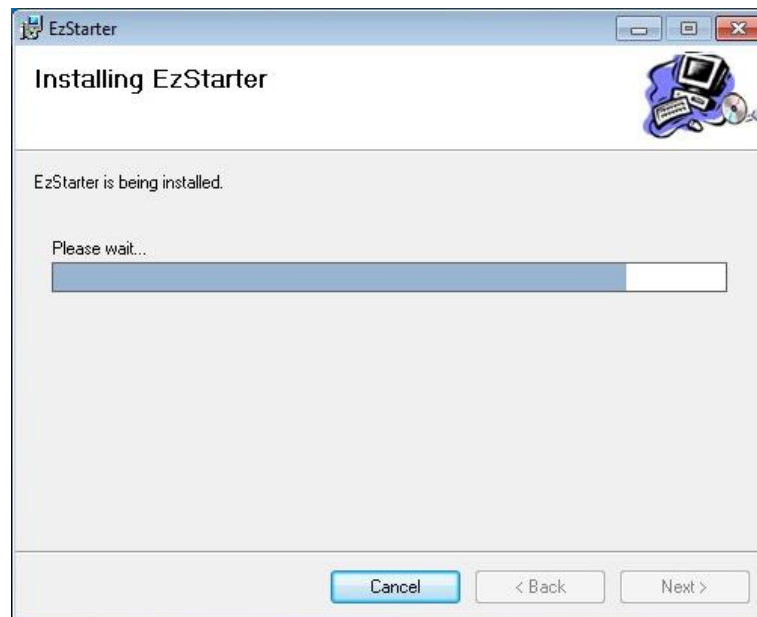

Step 5- Installation Complete

Select **Close** to end the software installation procedure and close the setup program.

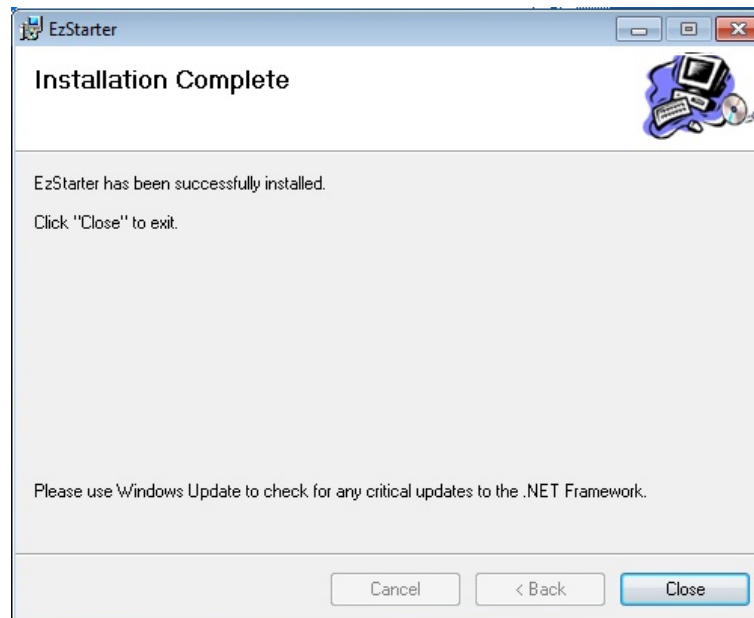

EzStarter Uninstallation

To completely remove the EzMate 401/601 Software-*EzStarter*, please select ‘Control Panel\Programs\Uninstall a program’ and select the EzStarter from the menu.

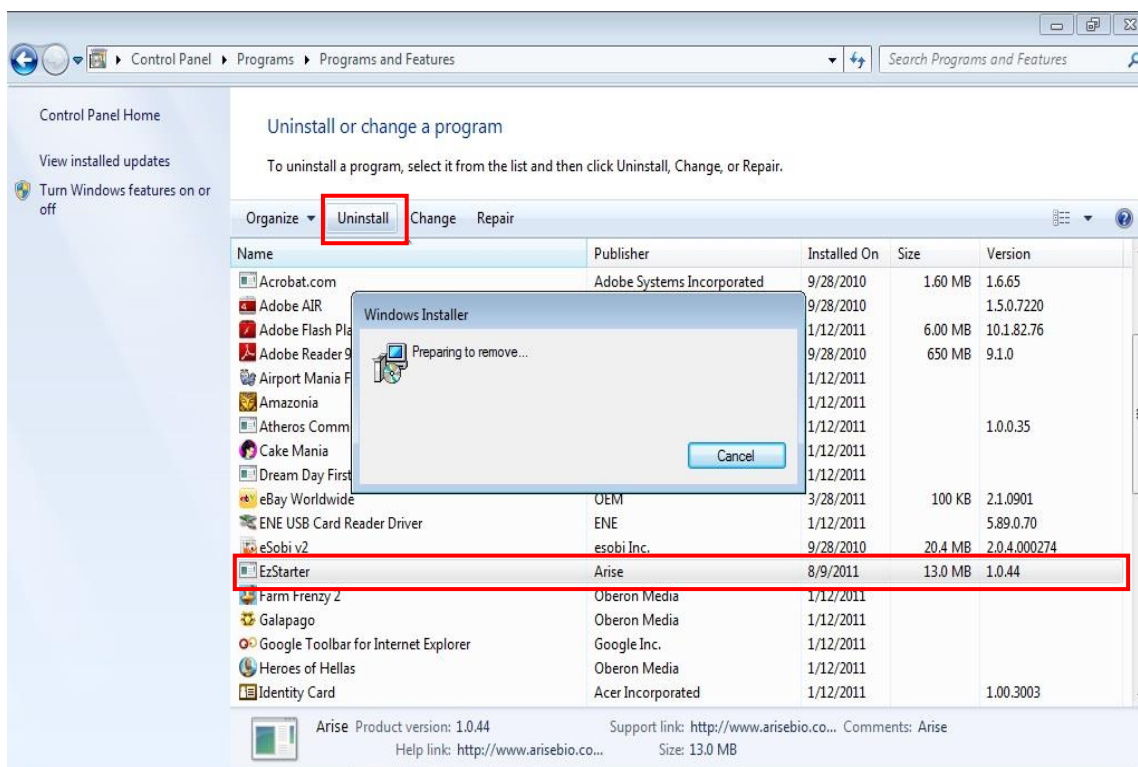

Appendix F : Ordering Information

Users are required to purchase the USB or RS-232 cable to connect the EzMate 401/601 and the PC. For USB connection, users are required to install the USB driver.

Catalog no.	Description
EzMate™ 401	
AREZ401-10000	4-position Automated Pipetting System, 15.6" Notebook Computer and EzStarter™ control software
EzMate™ 601	
AREZ601-10000	6-position Automated Pipetting System, 15.6" Notebook Computer and EzStarter™ control software
EzMate™ 401s	
EZ4SU00-100000	4-position Automated Pipetting System with UV / HEPA, 15.6" Notebook Computer and EzStarter™ control software
EZ4SUA0-100000	4-position Automated Pipetting System with UV / HEPA and 2-position Active Cooling / Heating module, 15.6" Notebook Computer and EzStarter™ control software
EZ4SUAC-100000	4-position Automated Pipetting System with UV / HEPA and 3-position Active Cooling / Heating module, 15.6" Notebook Computer and EzStarter™ control software
EzMate™ 601s	
EZ6SU00-100000	6-position Automated Pipetting System with UV / HEPA, 15.6" Notebook Computer and EzStarter™ control software
EZ6SUA0-100000	6-position Automated Pipetting System with UV / HEPA and 2-position Active Cooling / Heating module, 15.6" Notebook Computer and EzStarter™ control software
EZ6SUAC-100000	6-position Automated Pipetting System with UV / HEPA and 3-position Active Cooling / Heating module, 15.6" Notebook Computer and EzStarter™ control software
Interchangeable Automated Pipetting Modules	
275-azar01-00	1-channel, 50 µl Pipetting Module
275-azar02-00	8-channel, 50 µl Pipetting Module
275-azar03-00	1-channel, 200 µl Pipetting Module
275-azar04-00	8-channel, 200 µl Pipetting Module
275-azar04-10	8-channel, 200 µl Pipetting Module for Axygen
Robotic Tips	
T00-azar00-00	EzTip™ 50 µl, non-sterile, 96 tips/rack; 10 racks/pack
T00-azar01-00	EzTip™ 200 µl, non-sterile, 96 tips/rack; 10 racks/pack
T00-azar02-00	EzTip™ 50 µl, sterile, 96 tips/rack; 10 racks/pack
T00-azar03-00	EzTip™ 200 µl, sterile, 96 tips/rack; 10 racks/pack

EzMate™ 401/601 Automated Pipetting System

Catalog no.	Description
Accessories	
275-ezar21-00	96 tips rack adapter
275-ezar22-00	Elevated 96-well PCR plate adapter
275-ezar23-00	Elevated 384-well PCR plate adapter
275-ezar24-00	Deep well plate adapter
275-ezar26-00	4 x 2 1.5/2 ml tubes adapter
275-ezar27-00	3 x 2 2 ml storage tubes and 1 x 5 ml bottle adapter
275-ezar30-00	CoolBlock™ 96 adapter for 96-well PCR plates
275-ezar31-00	CoolBlock™ 384 adapter for 384-well PCR plates
275-ezar34-00	CoolBlock™ R10 adapter for 4 x 2 1.5/2 ml tubes
275-ezar35-00	CoolBlock™ R20 adapter for 3 x 2 2 ml storage tubes and 1 x 5ml bottle
275-ezar37-00	CoolBlock™ 20-well adapter for 1.5/2 ml tube
275-ezar40-00	Elevated 20-well 1.5/2 ml tube adapter
275-ezar47-00	Reservoir adapter
275-ezar49-00	Disposable 80ml reservoir x 20 pcs
275-ezar51-00	Disposable used tip tray x 10 sets
275-ezar66-00	HLA typing adapter for 60/72 well
275-ezar67-00	HLA typing adapter for 96 well
275-ezar68-00	0.5ml tube adapter for 20 well adapter
275-ezar72-00	3 x 15ml reservoirs adapter
275-ezar73-00	Disposable 15ml reservoir x 9 pcs
275-ezar74-00	3 x 8-strip tubes adapter
275-ezar76-00	Elevated ELISA / cell culture adapter
275-ezar78-00	Illumina 48-well plate adapter
275-ezar79-00	R1 Active Cooling / Heating Adapter
275-ezar80-00	R2 Active Cooling / Heating Adapter
275-ezar81-00	96-well PCR plate Active Cooling / Heating Adapter
275-ezar82-00	384-well PCR plate Active Cooling / Heating Adapter

ARISE BIOTECH CORPORATION

3F, No.5, Alley 2, Sih-wei Lane, Jhong-jheng Rd., New Taipei City, 231, Taiwan, R.O.C.

TEL: 886-2-8667-5441 FAX: 886-2-8667-1468

E-mail: sales@arisebio.com.tw

Web Site: www.arisebio.com.tw

Printed in Taiwan

P/N: 401-ezar01-22

December, 2013